

GF8 C.T.S.

Freewheel

TYPE: Freewheel, Built-in freewheels, Bearing supported roller type freewheel without any sealing, d (8..20)

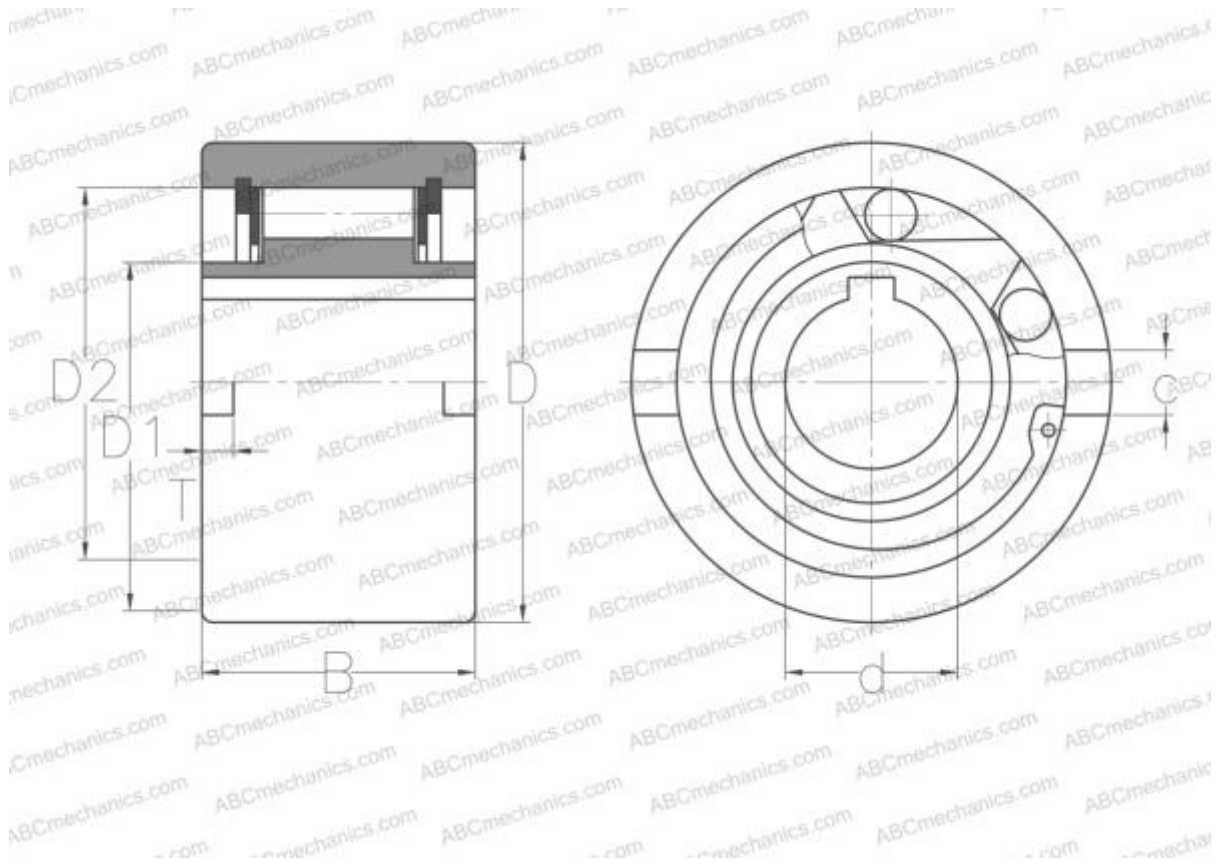

Technical specification

DIMENSIONS, MM

d	8,000
D	37,000
D1	20,000
D2	30,000
B	20,000
c	6,000
T	3,000

MANUFACTURER [C.T.S.](#)

INTERCHANGE

ABC	NFR 8
STIEBER	NFR 8
GMN	VGF8
RINGSPANN	FNR8
RENOLD	REGF8