

FNR8 RINGSPANN

Freewheel

TYPE: Freewheel, Built-in freewheels, Bearing supported roller type freewheel without any sealing, d (8..20)

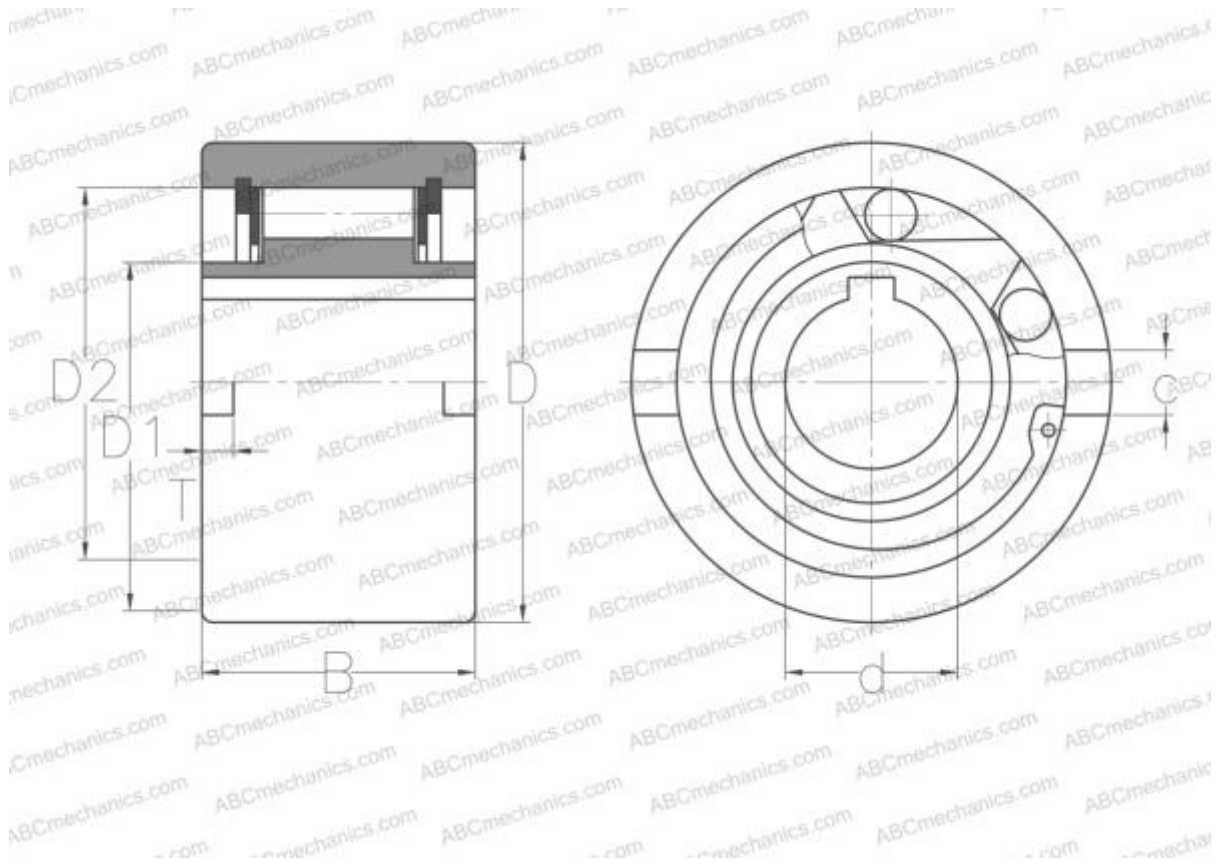

Technical specification

DIMENSIONS, MM

d	8,000
D	37,000
D1	20,000
D2	30,000
B	20,000
c	6,000
T	3,000

MANUFACTURER

[RINGSPANN](#)

INTERCHANGE

ABC	NFR 8
STIEBER	NFR 8
C.T.S.	GF8
GMN	VGF8
RENOLD	REGF8