

## FNR25 RINGSPANN

Freewheel

TYPE: Freewheel, Built-in freewheels, Bearing supported roller type freewheel without any sealing, d (>25)

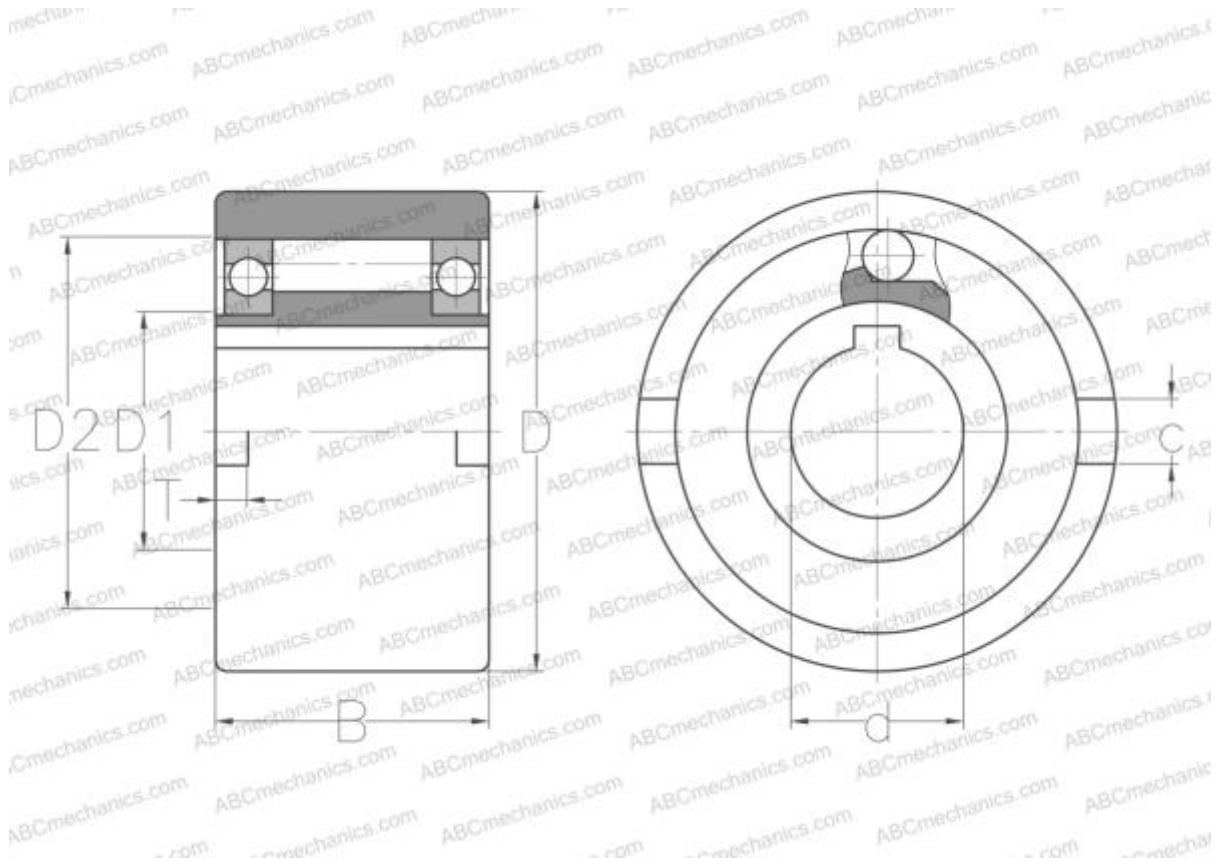

### Technical specification

#### DIMENSIONS, MM

d	25,000
D	80,000
D1	40,000
D2	68,000
B	40,000
c	9,000
T	4,000

#### MANUFACTURER

[RINGSPANN](#)

#### INTERCHANGE

ABC	<a href="#">NFR 25</a>
STIEBER	<a href="#">NFR 25</a>
C.T.S.	<a href="#">GF25</a>
GMN	<a href="#">VGF25</a>
RENOLD	<a href="#">REGF25</a>