

REGF25 RENOLD

Freewheel

TYPE: Freewheel, Built-in freewheels, Bearing supported roller type freewheel without any sealing, d (>25)

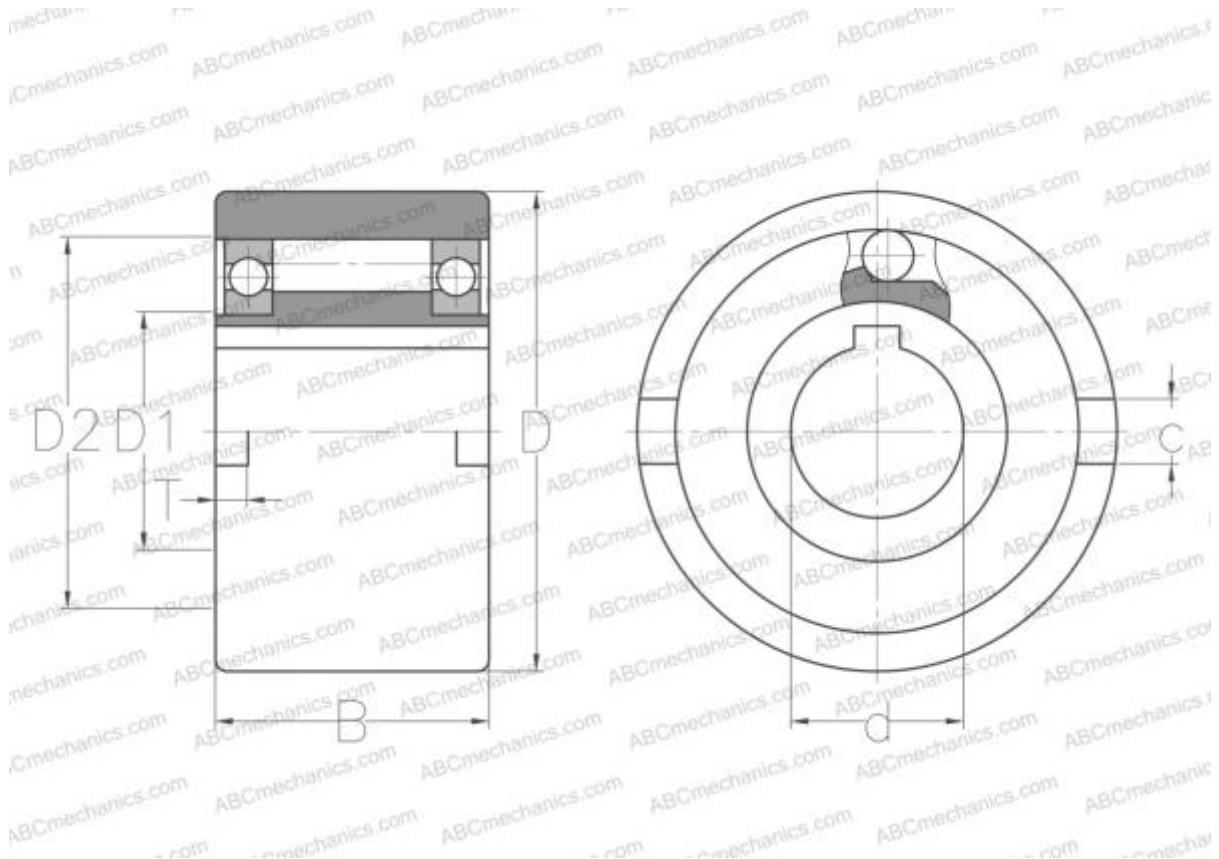

Technical specification

DIMENSIONS, MM

d	25,000
D	80,000
D1	40,000
D2	68,000
B	40,000
c	9,000
T	4,000

MANUFACTURER

[RENOLD](#)

INTERCHANGE

ABC	NFR 25
STIEBER	NFR 25
C.T.S.	GF25
GMN	VGF25
RINGSPANN	FNR25