

NFR 30 STIEBER

Freewheel

TYPE: Freewheel, Built-in freewheels, Bearing supported roller type freewheel without any sealing, d (>25)

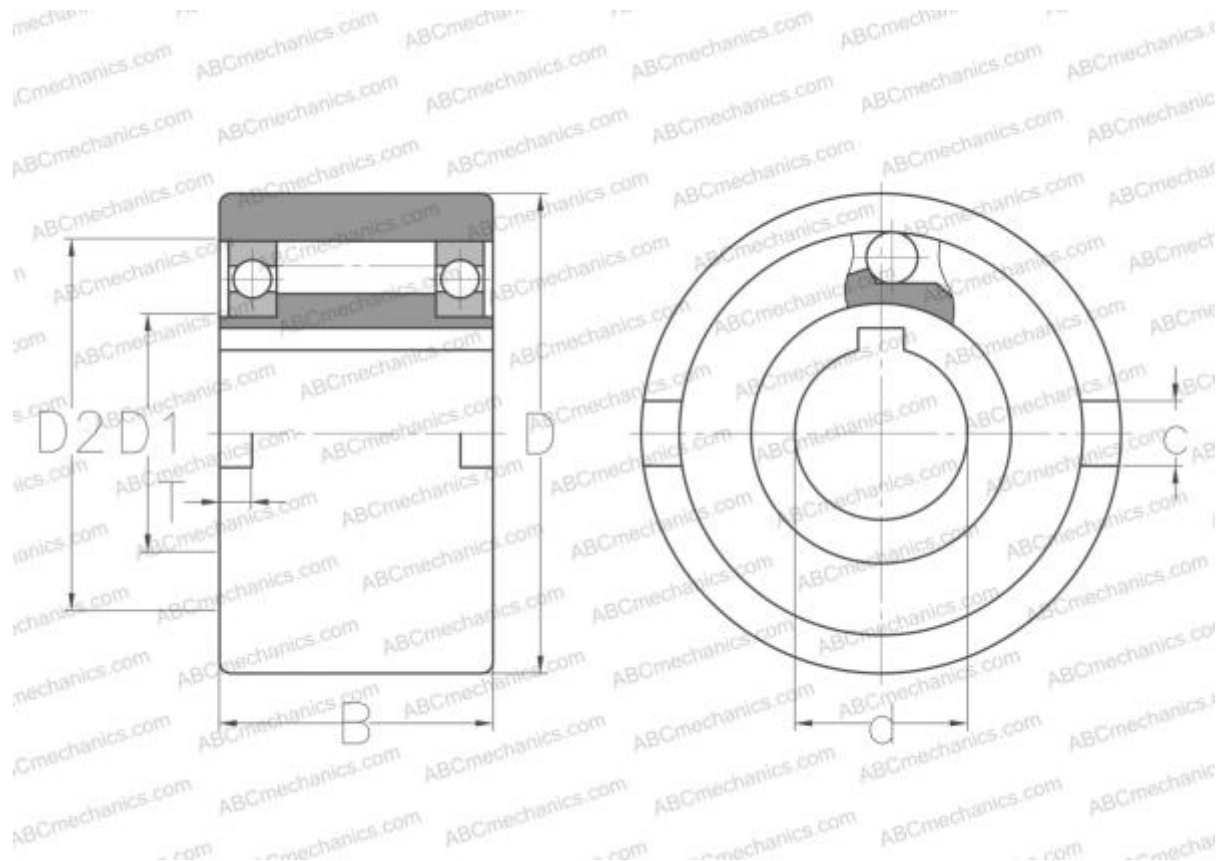

Technical specification

DIMENSIONS, MM

d	30,000
D	90,000
D1	45,000
D2	75,000
B	48,000
c	12,000
T	5,000

MANUFACTURER [STIEBER](#)

INTERCHANGE

ABC	NFR 30
C.T.S.	GF30
GMN	VGF30
RINGSPANN	FNR30
RENOLD	REGF30