

## GFRN 20 STIEBER

Freewheel

TYPE: Freewheel, Self-contained freewheels, Roller type freewheels, using two 160.. series bearings, require oil lubrication, keyway on the outside diameter

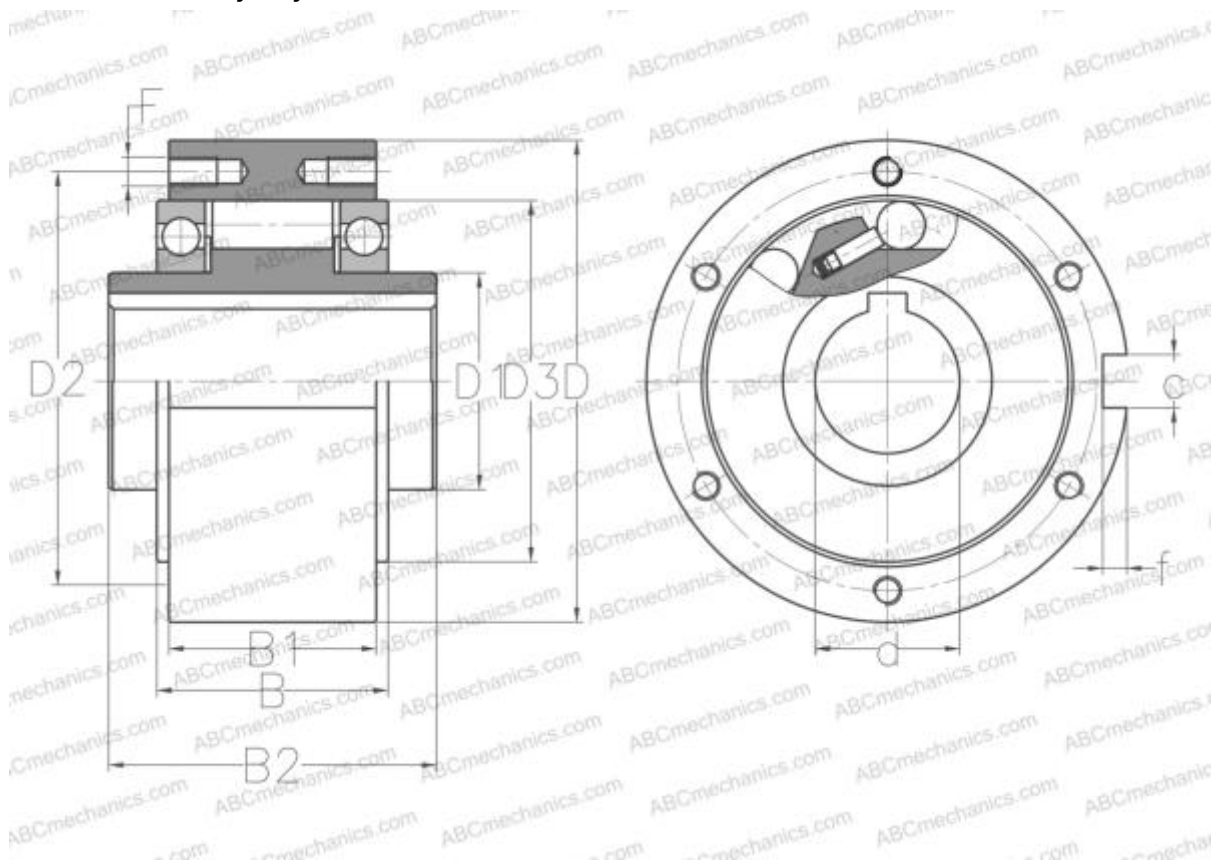

### Technical specification

#### DIMENSIONS, MM

d	20,000
D	75,000
D1	30,000
D2	64,000
D3	55,000
B	39,000
B1	34,000
B2	57,000
f	3,500
c	6,000
F	M5

**MANUFACTURER** [STIEBER](#)

#### INTERCHANGE

ABC [GFRN 20](#)