

AL 12 STIEBER

Freewheel

TYPE: Freewheel, Self-contained freewheels, Roller type freewheels, using two 160.. series bearings, require oil lubrication, through holes for mounting

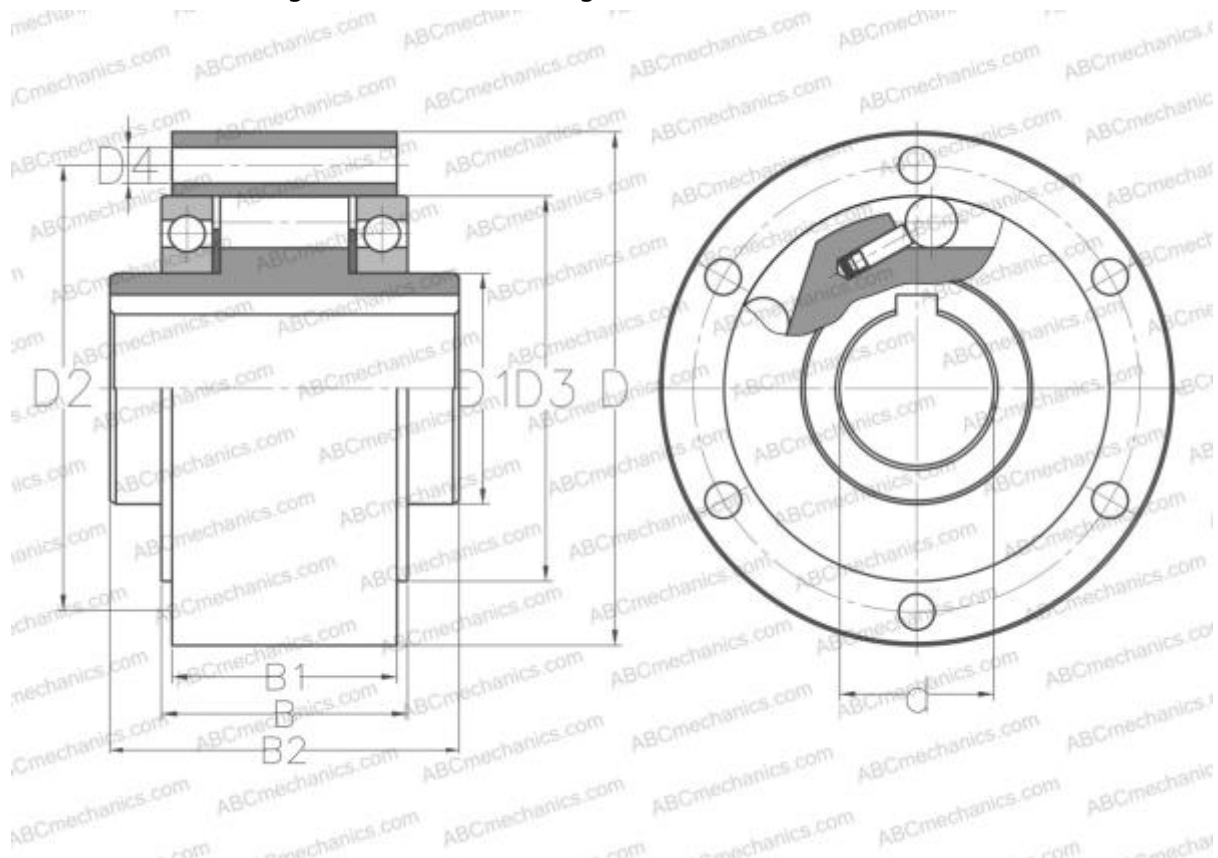

Technical specification

DIMENSIONS, MM

d	12,000
D	62,000
D1	20,000
D2	51,000
D3	42,000
D4	5,500
B	27,000
B1	20,300
B2	42,000

MANUFACTURER [STIEBER](#)

INTERCHANGE

ABC [AL 12](#)