

## ALP 12 STIEBER

Freewheel

TYPE: Freewheel, Self-contained freewheels, Roller type freewheels, using two 160.. series bearings, require oil lubrication, through holes for mounting, keyway on the outside diameter

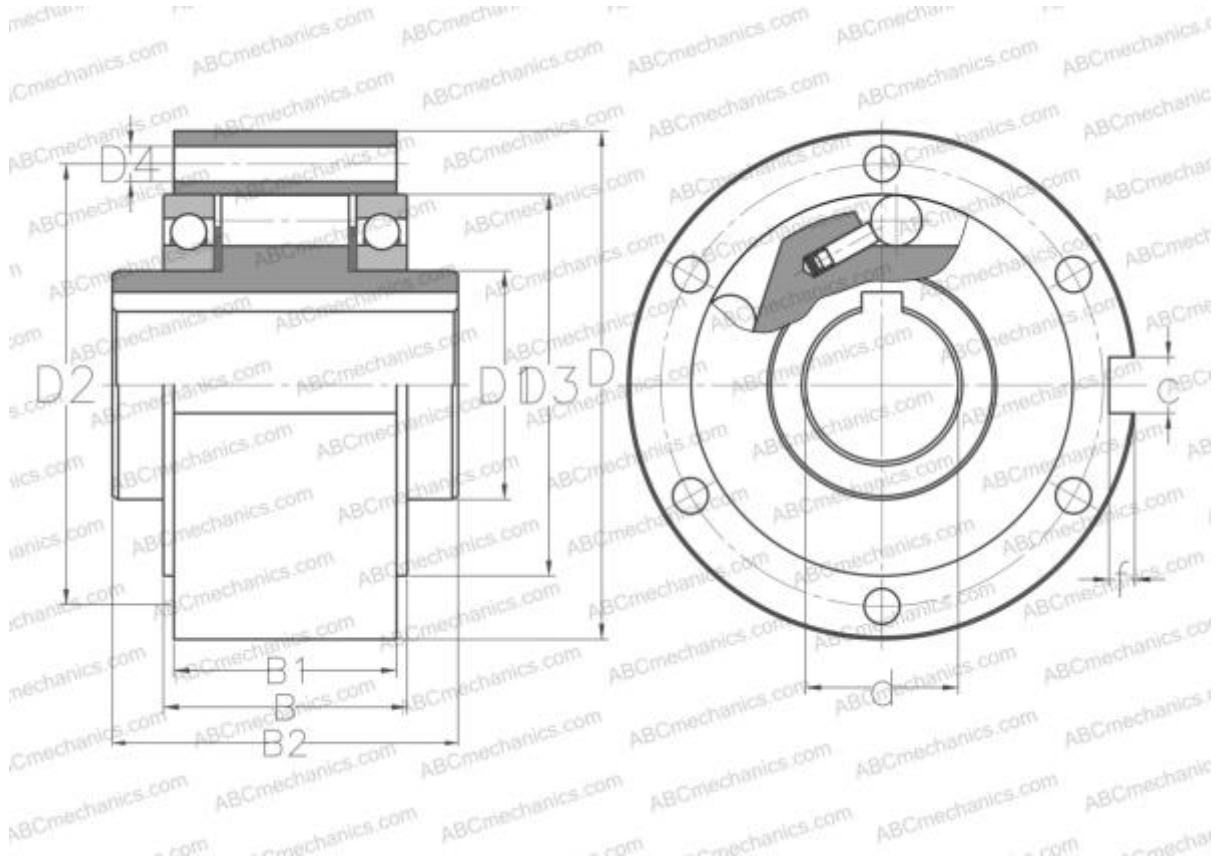

### Technical specification

#### DIMENSIONS, MM

d	12,000
D	62,000
D1	20,000
D2	51,000
D3	42,000
D4	5,500
B	27,000
B1	20,300
B2	42,000
f	2,400
c	4,000

**MANUFACTURER** [STIEBER](#)

#### INTERCHANGE

ABC [ALP 12](#)