

ALP 15 ABC

Freewheel

TYPE: Freewheel, Self-contained freewheels, Roller type freewheels, using two 160.. series bearings, require oil lubrication, through holes for mounting, keyway on the outside diameter

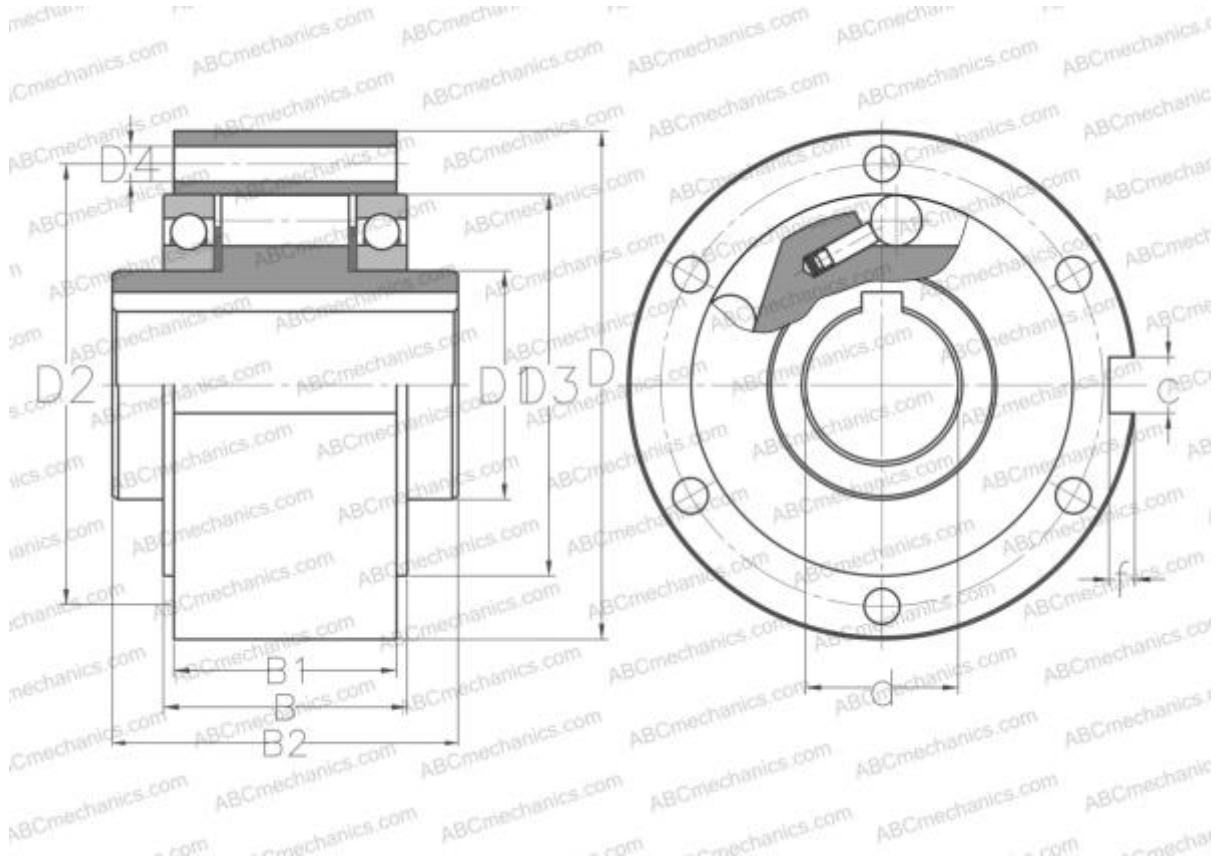

Technical specification

DIMENSIONS, MM

d	15,000
D	68,000
D1	25,000
D2	56,000
D3	47,000
D4	5,500
B	34,100
B1	30,300
B2	52,000
f	2,900
c	5,000

MANUFACTURER [ABC](#)

INTERCHANGE

STIEBER [ALP 15](#)