

ALP 25 STIEBER

Freewheel

TYPE: Freewheel, Self-contained freewheels, Roller type freewheels, using two 160.. series bearings, require oil lubrication, through holes for mounting, keyway on the outside diameter

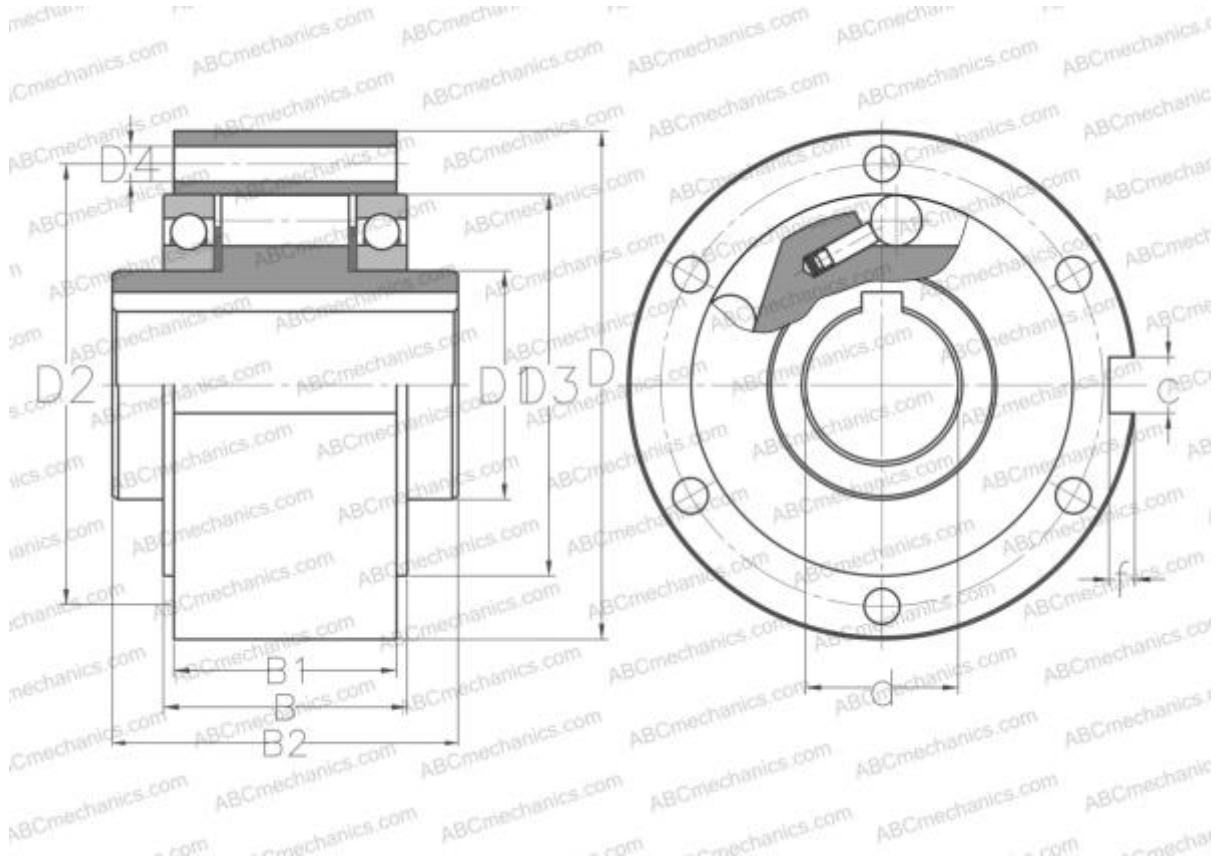

Technical specification

DIMENSIONS, MM

d	25,000
D	90,000
D1	40,000
D2	78,000
D3	68,000
D4	5,500
B	42,100
B1	37,300
B2	60,000
f	4,100
c	8,000

MANUFACTURER [STIEBER](#)

INTERCHANGE

ABC [ALP 25](#)