

## MCYRR 6 SX McGill

Yoke type track roller

TYPE: Roller bearings, Yoke type track rollers, With axial guidance, Gap seals on both side, cylindrical outer ring

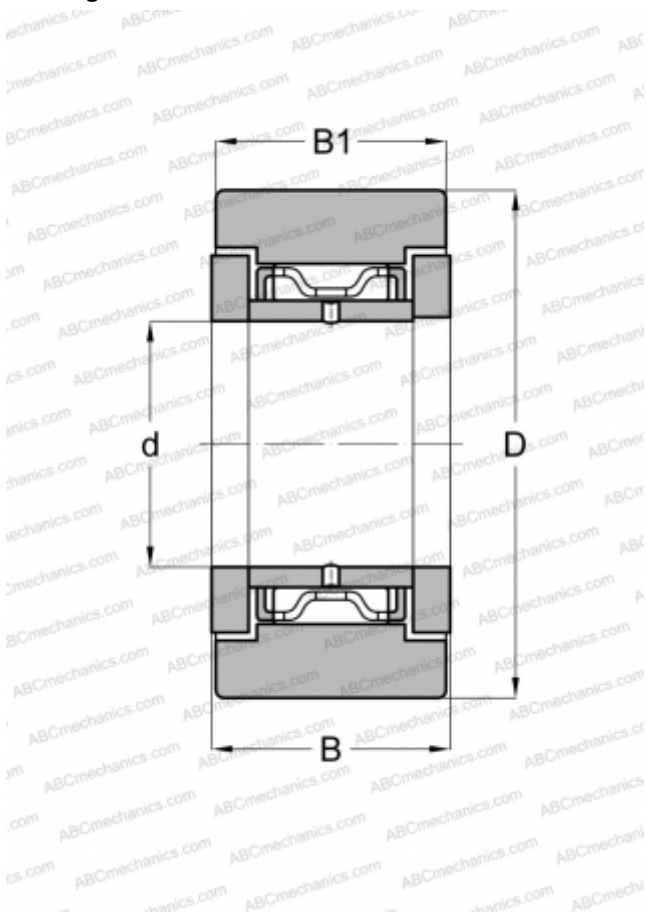

### Technical specification

#### DIMENSIONS, MM

d	6,000
D	19,000
B	12,000
B1	11,000

#### MANUFACTURER

[McGill](#)

#### INTERCHANGE

ABC	<a href="#">NATR 6 X</a>
INA	<a href="#">NATR6-X</a>
FAG	<a href="#">NATR 6 DZ</a>
SKF	<a href="#">NATR 6 X</a>
KOYO	<a href="#">NATR6DZ</a>
JNS	<a href="#">NART6X</a>
NTN	<a href="#">NATR6X</a>