

NATR 6 X SKF

Yoke type track roller

TYPE: Roller bearings, Yoke type track rollers, With axial guidance, Gap seals on both side, cylindrical outer ring

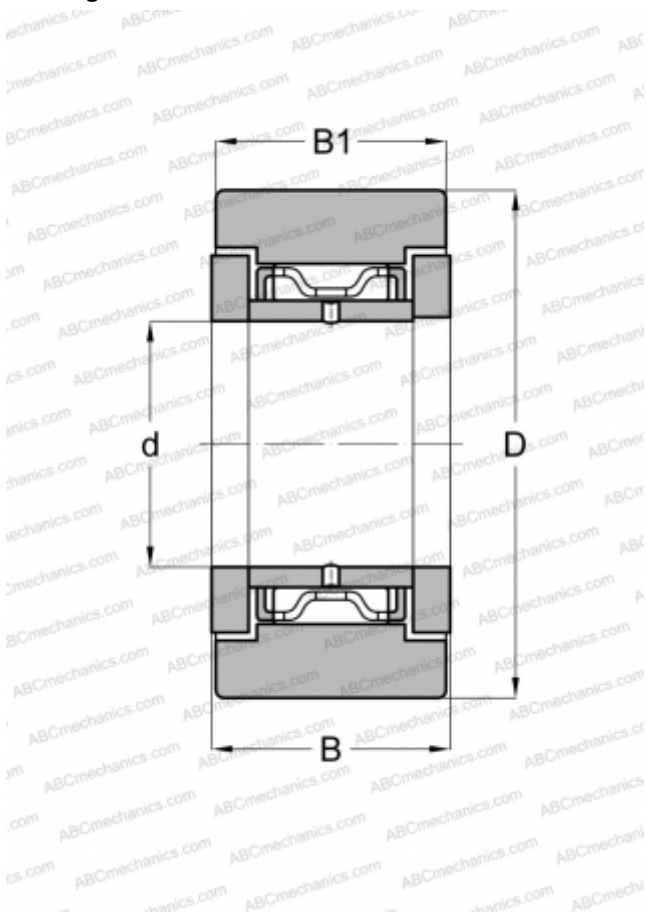

Technical specification

DIMENSIONS, MM

d	6,000
D	19,000
B	12,000
B1	11,000

MANUFACTURER

[SKF](#)

INTERCHANGE

ABC	NATR 6 X
INA	NATR6-X
FAG	NATR 6 DZ
McGill	MCYRR 6 SX
KOYO	NATR6DZ
JNS	NART6X
NTN	NATR6X