

NATR6XLL NTN

Yoke type track roller

TYPE: Roller bearings, Yoke type track rollers, With axial guidance, Sealing rings on both sides, cylindrical outer ring

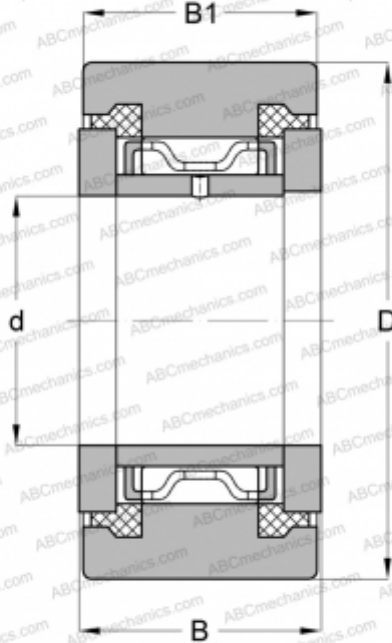

Technical specification

DIMENSIONS, MM

d	6,000
D	19,000
B	12,000
B1	11,000

MANUFACTURER

[NTN](#)

INTERCHANGE

ABC	NATR 6 PPX
McGill	MCYRR 6 SX
SKF	NATR 6 PPX
INA	NATR6-X-PP
JNS	NART6UUX