

NART8UUX JNS

Yoke type track roller

TYPE: Roller bearings, Yoke type track rollers, With axial guidance, Sealing rings on both sides, cylindrical outer ring

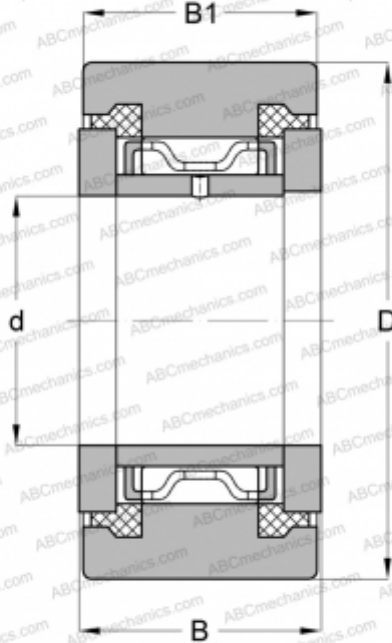

Technical specification

DIMENSIONS, MM

d	8,000
D	24,000
B	15,000
B1	14,000

MANUFACTURER

[JNS](#)

INTERCHANGE

ABC	NATR 8 PPX
McGill	MCYRR 8 SX
SKF	NATR 8 PPX
INA	NATR8-X-PP
NTN	NATR8XLL