

CF 3 BR ABC

Cam followers

TYPE: Roller bearings, Stud type track rollers, With axial guidance, gap seals on both side, hex hole

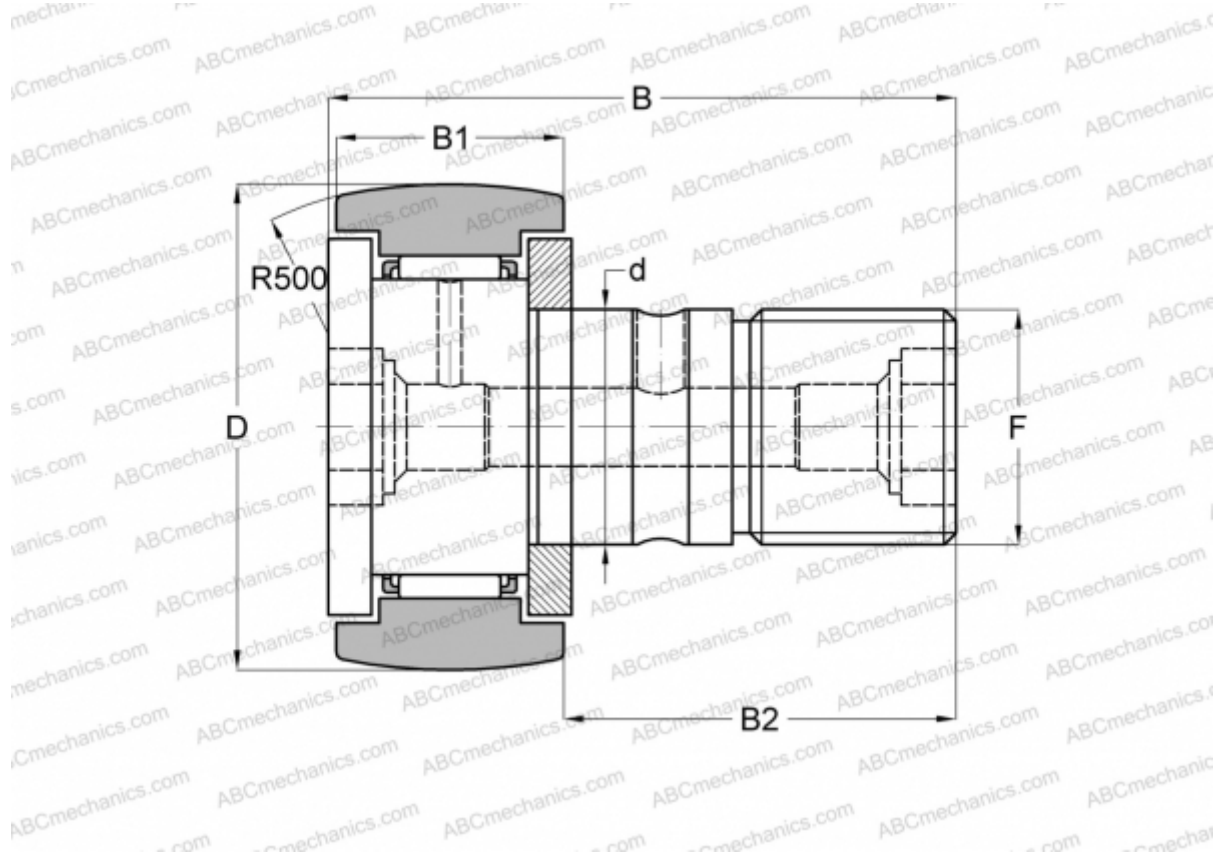

Technical specification

DIMENSIONS, MM

d	3,000
D	10,000
B	17,000
B1	7,000
B2	9,000
F	M3x0.5

MANUFACTURER [ABC](#)

INTERCHANGE

IKO	CF 3 BR
JNS	CF3RA
NTN	KR10T2H/3AS