

CF4RA JNS

Cam followers

TYPE: Roller bearings, Stud type track rollers, With axial guidance, gap seals on both side, hex hole

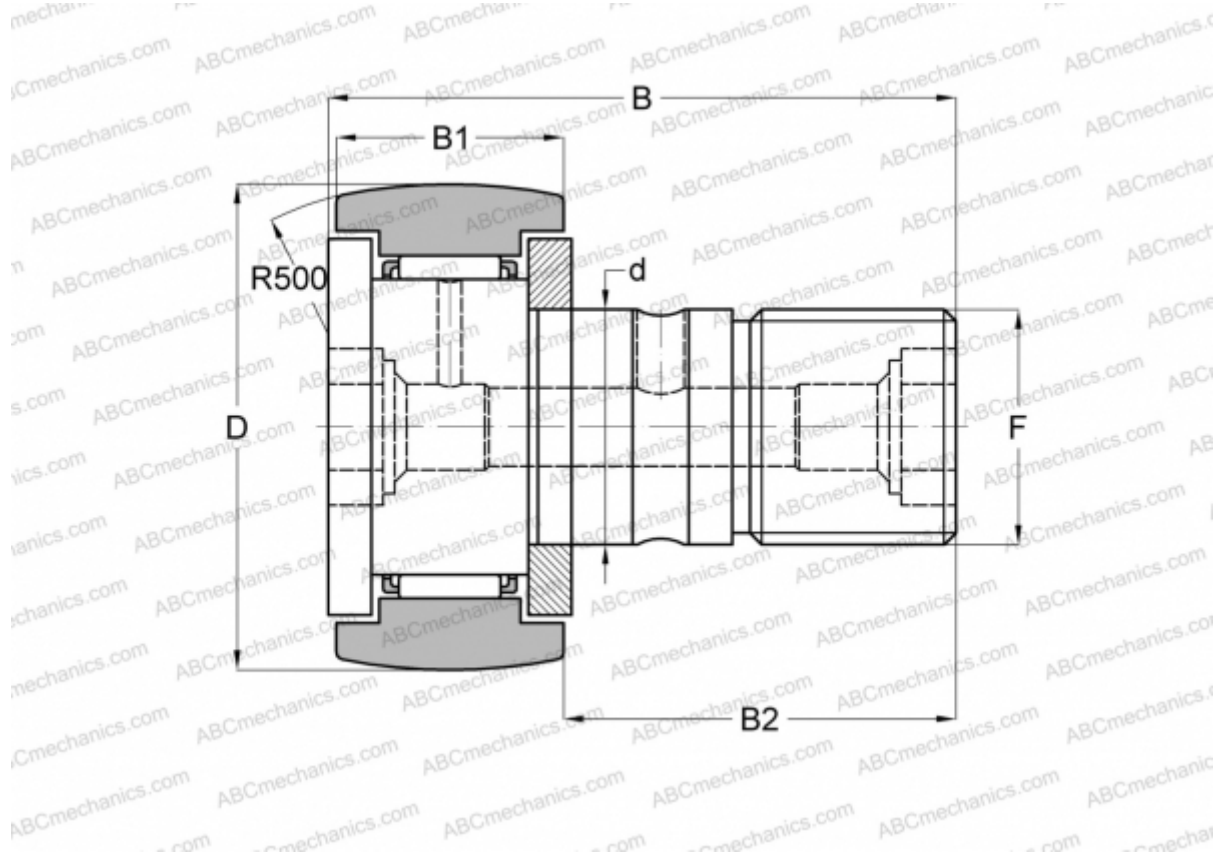

Technical specification

DIMENSIONS, MM

d	4,000
D	12,000
B	20,000
B1	8,000
B2	11,000
F	M4x0.7

MANUFACTURER [JNS](#)

INTERCHANGE

ABC	CF 4 BR
IKO	CF 4 BR
NTN	KR12T2H/3AS