

KR10T2XH/3AS NTN

Cam followers

TYPE: Roller bearings, Stud type track rollers, With axial guidance, gap seals on both side, cylindrical outer ring, hex hole

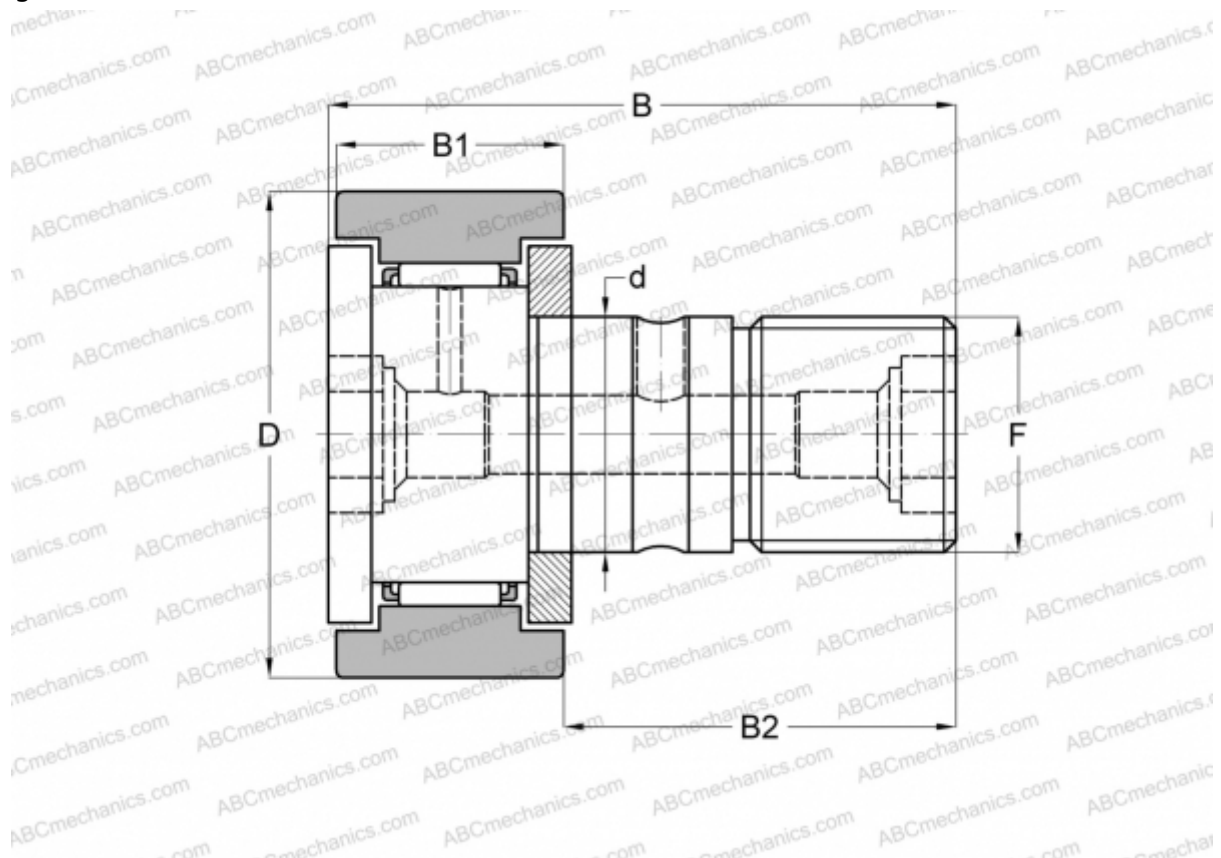

Technical specification

DIMENSIONS, MM

d	3,000
D	10,000
B	17,000
B1	7,000
B2	9,000
F	M3x0.5

MANUFACTURER [NTN](#)

INTERCHANGE

ABC	CF 3 B
IKO	CF 3 B
JNS	CF3A