

CF-RU1-8 ABC

Cam followers

TYPE: Roller bearings, Stud type track rollers, With axial guidance, gap seals on both side, centralized lubrication type

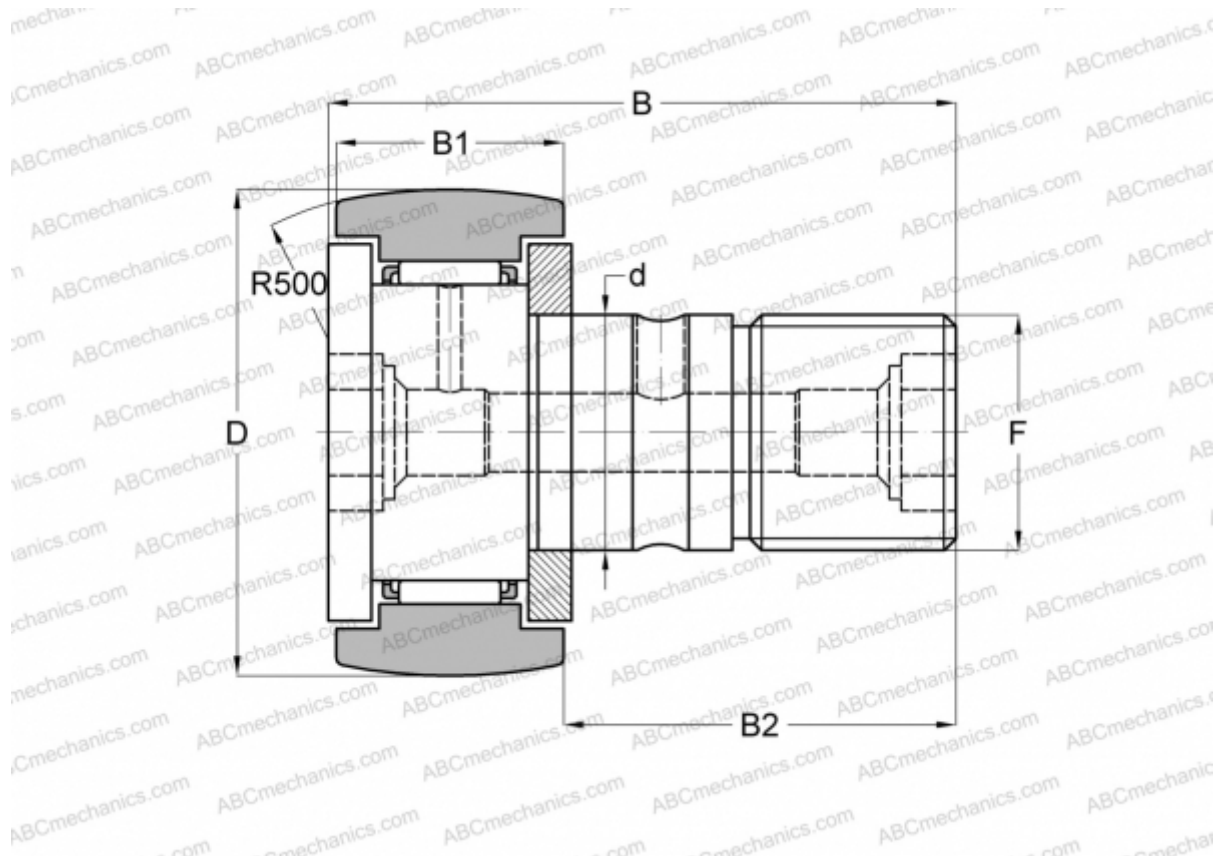

Technical specification

DIMENSIONS, MM

d	8,000
D	19,000
B	32,200
B1	11,000
B2	20,000
F	M8x1.25

MANUFACTURER [ABC](#)

INTERCHANGE

IKO	CF-RU1-8
JNS	CFT8UUR
NTN	KRT19LL