

CFT8UU JNS

Cam followers

TYPE: Roller bearings, Stud type track rollers, With axial guidance, gap seals on both side, centralized lubrication type, cylindrical outer ring

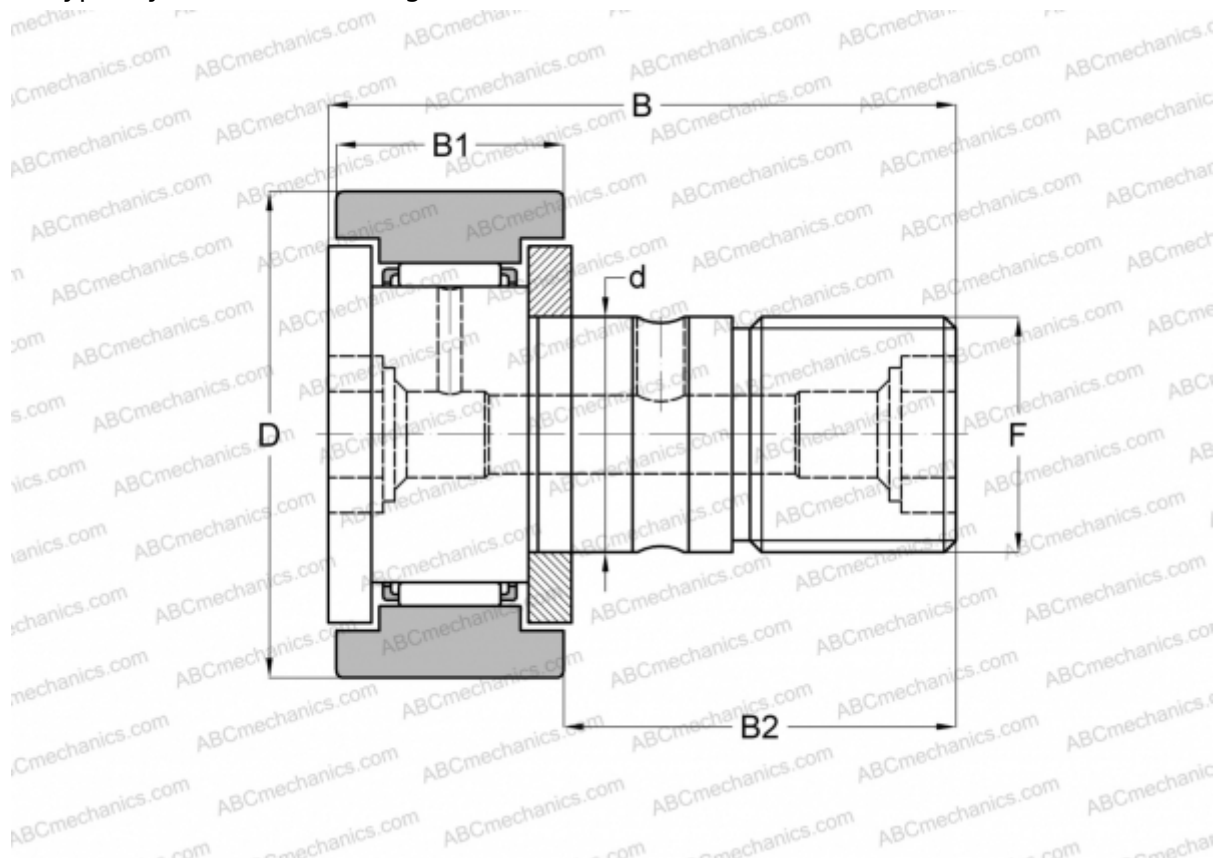

Technical specification

DIMENSIONS, MM

d	8,000
D	19,000
B	32,200
B1	11,000
B2	20,000
F	M8x1.25

MANUFACTURER [JNS](#)

INTERCHANGE

ABC	CF-FU1-8
IKO	CF-FU1-8
NTN	KRT19XLL