

## CRH 8-1 VUU IKO

Cam followers

TYPE: Roller bearings, Stud type track rollers, With axial guidance, full complement bearing, sealing rings on both sides, cylindrical outer ring, heavy duty, inch size

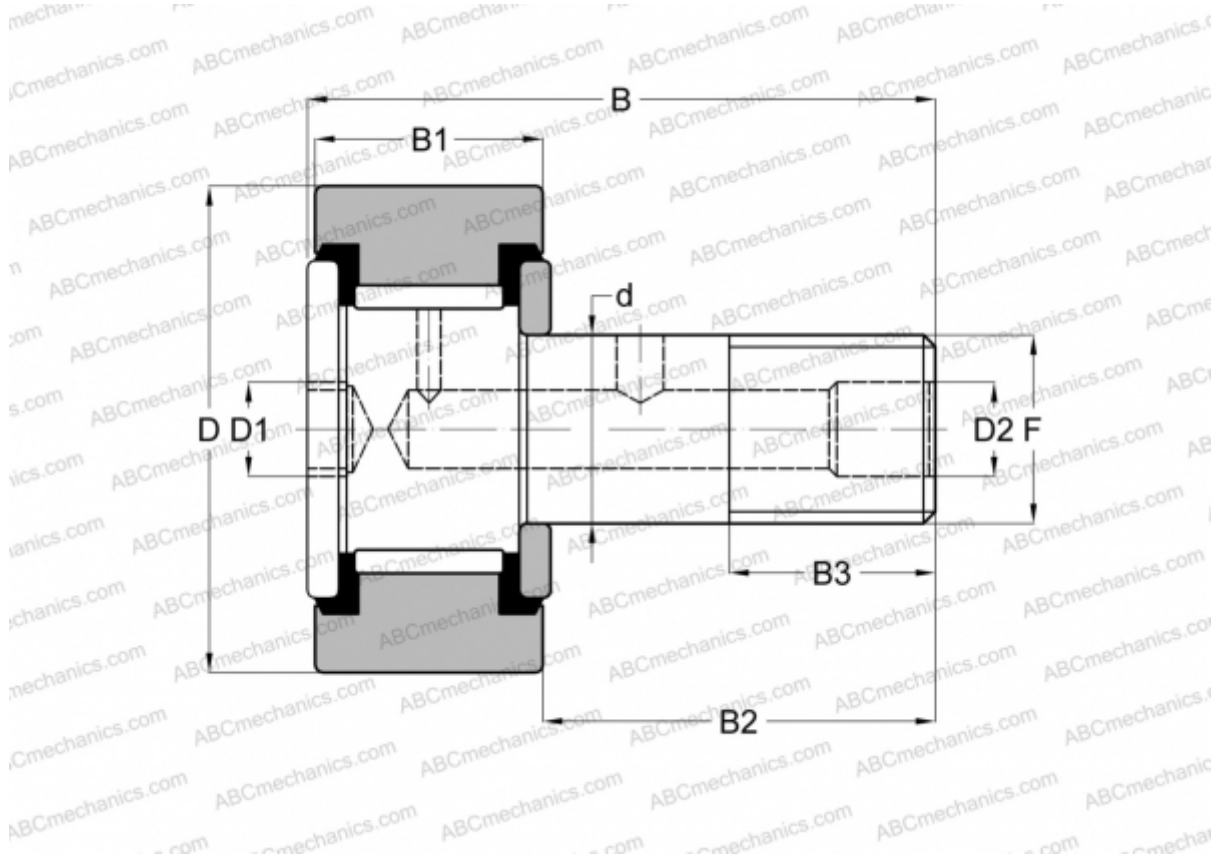

### Technical specification

#### DIMENSIONS, MM

d	6,350
D	12,700
B	27,050
B1	11,100
B2	15,950
F	1/4-28

#### MANUFACTURER

[IKO](#)

#### INTERCHANGE

ABC	<a href="#">CRH 8-1 VUU</a>
McGill	<a href="#">CFH 1/2 S</a>

#### REPLACES

CRH 8-1 VBUU