

CRH 9 VUU ABC

Cam followers

TYPE: Roller bearings, Stud type track rollers, With axial guidance, full complement bearing, sealing rings on both sides, cylindrical outer ring, heavy duty, inch size

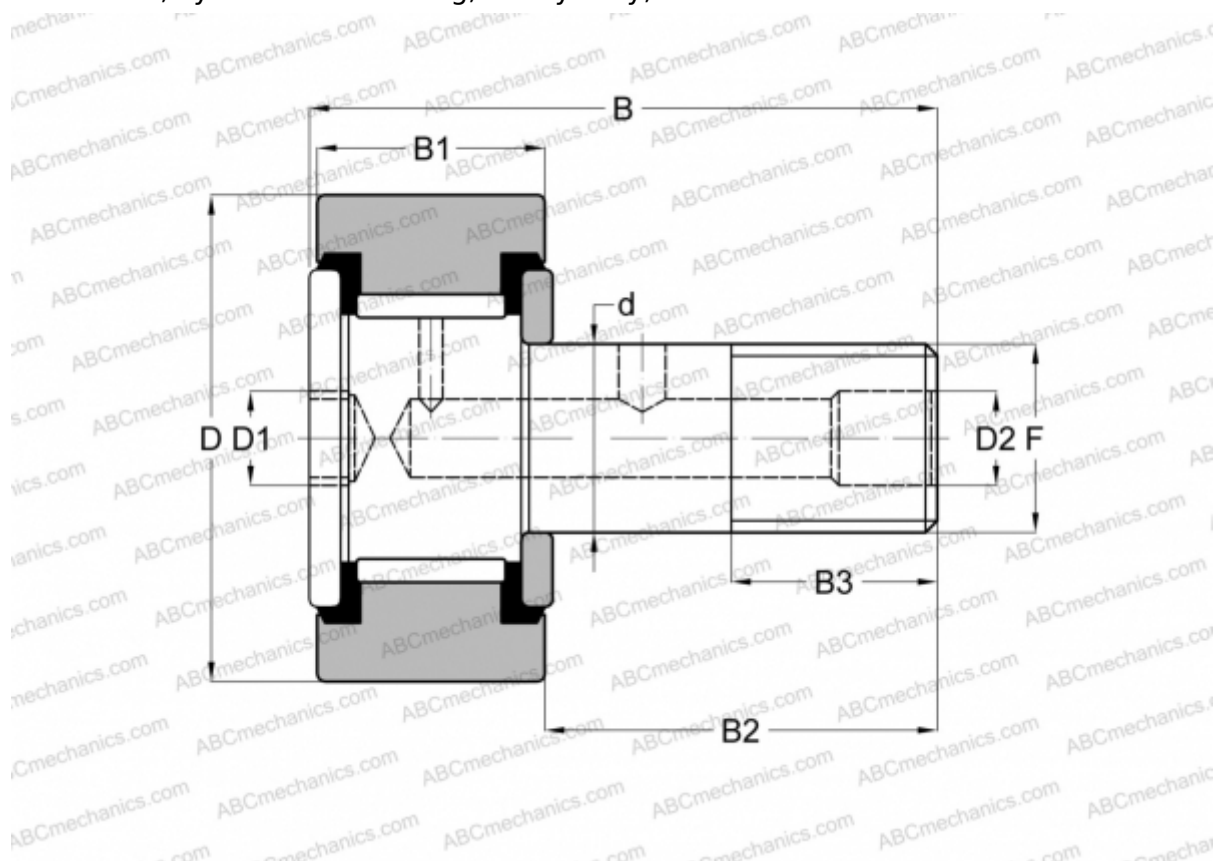

Technical specification

DIMENSIONS, MM

d	6,350
D	14,288
B	27,050
B1	11,100
B2	15,950
F	1/4-28

MANUFACTURER [ABC](#)

INTERCHANGE

IKO	CRH 9 VUU
McGill	CFH 9/16 S