

AS0515 INA

Axial bearing washer

TYPE: Rolling bearing parts and accessories, Rolling elements, Axial bearing washers, Type AS, suitable for AXK AND K811..

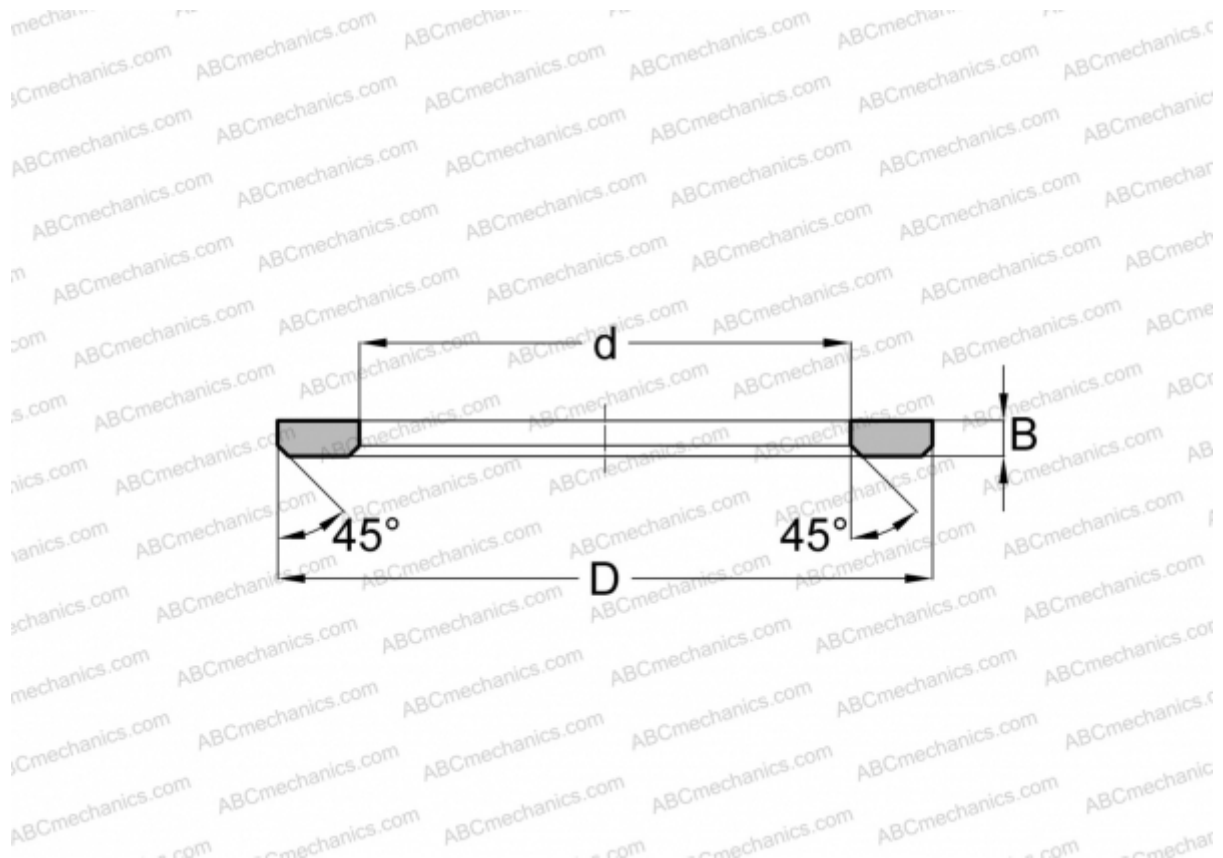

Technical specification

DIMENSIONS, MM

d	5,000
D	15,000
B	1,000

MANUFACTURER [INA](#)

INTERCHANGE

ABC	AS0515
FAG	AS0515
SKF	AS0515