

PHG 344-MXL-037 SKF

Classical timing belt

TYPE: Classical timing belts, Oneway, Classical, Section MXL (SKF)

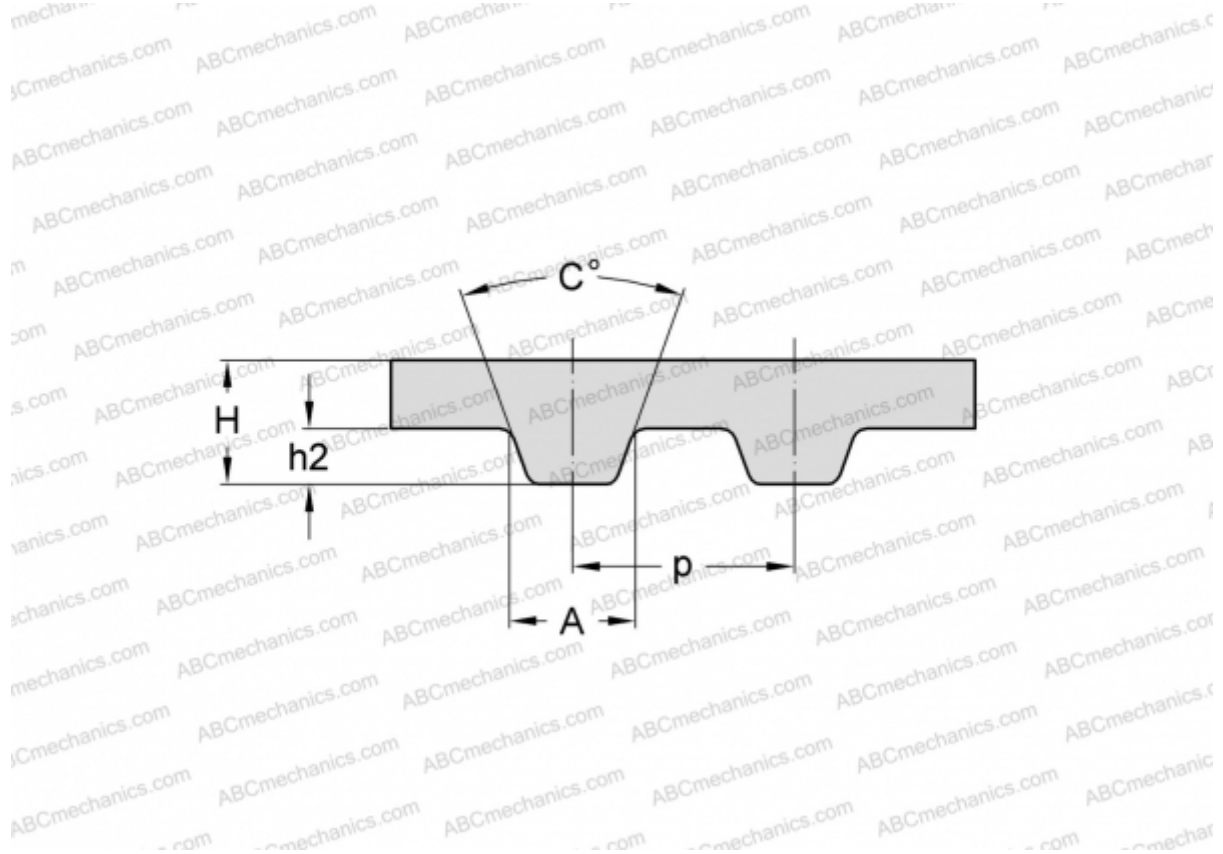

Technical specification

DIMENSIONS, MM

Pitch teeth, p	2,032
Estimated length	87,380
Width, W	9,398
Height, H	1,140
C	40,000
h2	0,510
A	1,140
Number of teeth	43

MANUFACTURER

[SKF](#)