

## PHG 560-MXL-037 SKF

Classical timing belt

TYPE: Classical timing belts, Oneway, Classical, Section MXL (SKF)

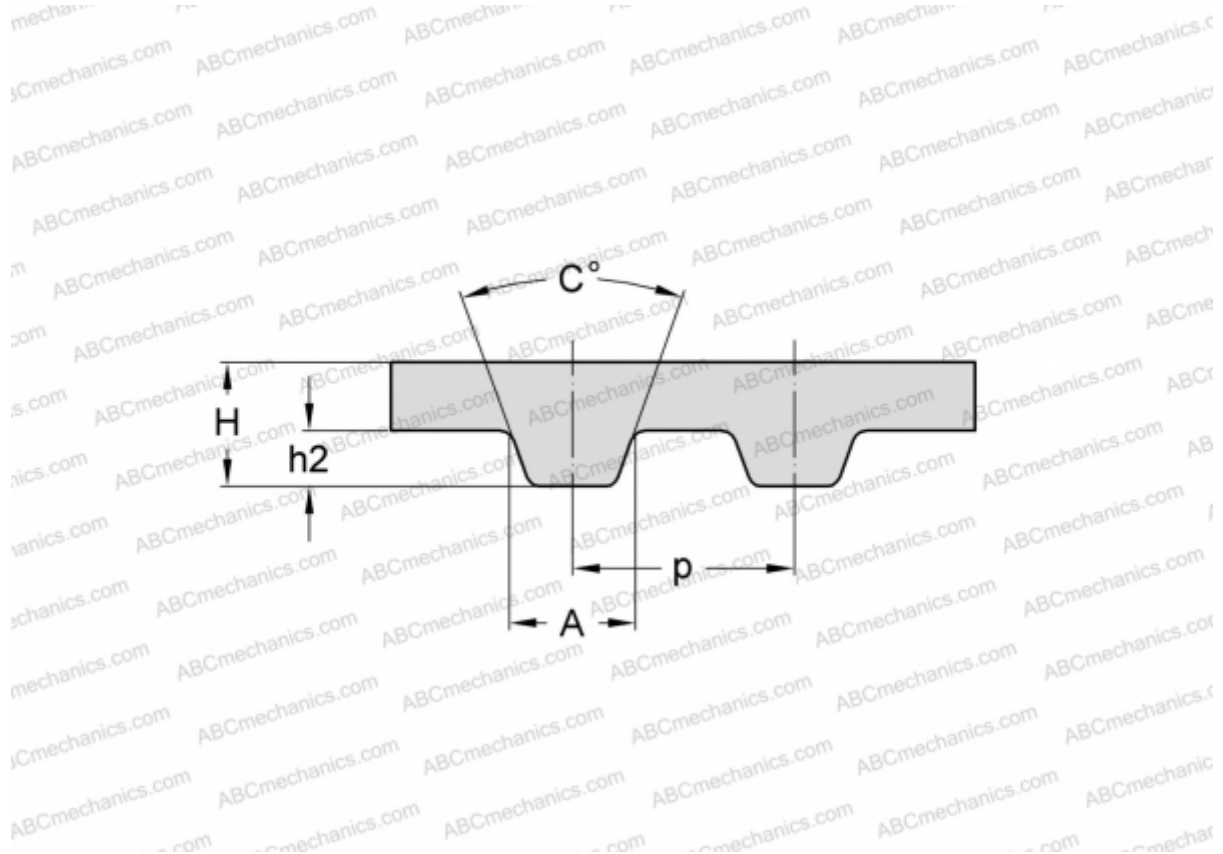

### Technical specification

#### DIMENSIONS, MM

Pitch teeth, p	2,032
Estimated length	142,240
Width, W	9,398
Height, H	1,140
C	40,000
h2	0,510
A	1,140
Number of teeth	70

#### MANUFACTURER

[SKF](#)