

## PHG 1856-MXL-031 SKF

Classical timing belt

TYPE: Classical timing belts, Oneway, Classical, Section MXL (SKF)

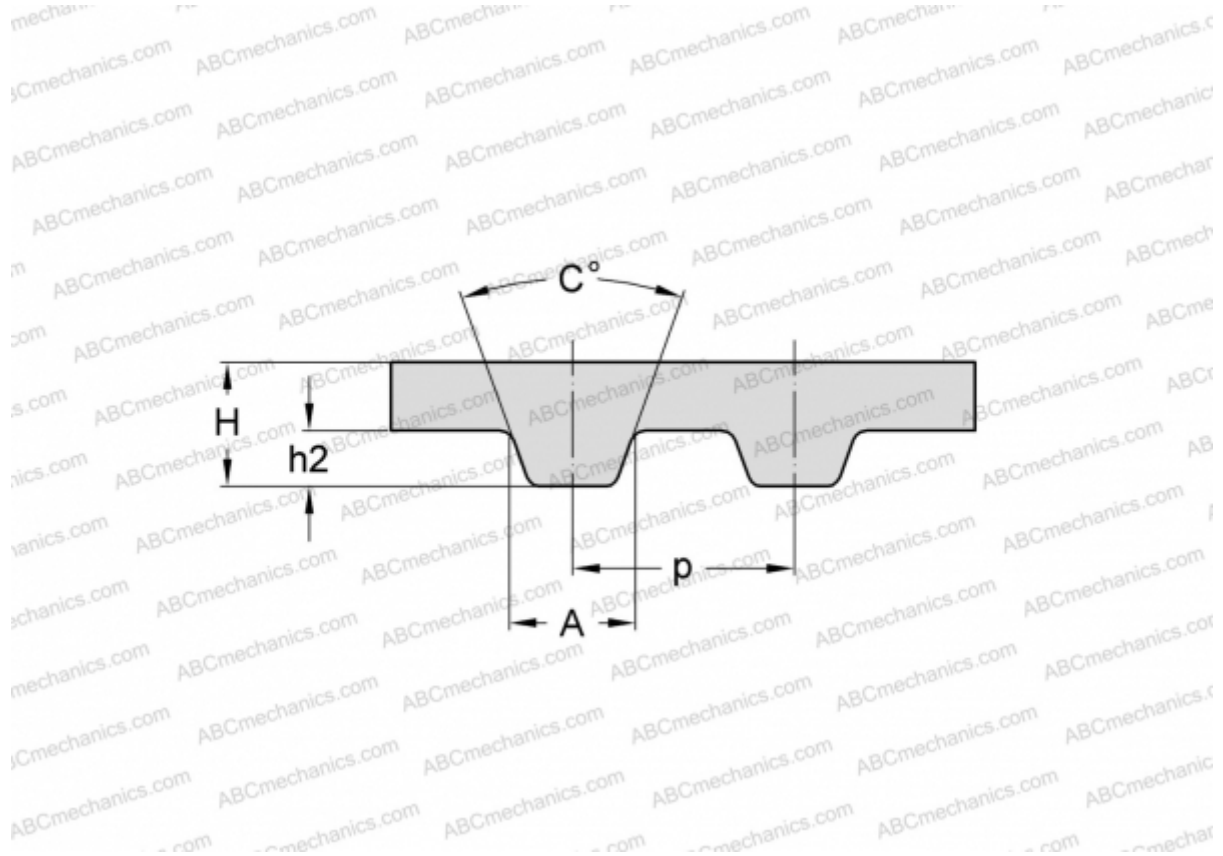

### Technical specification

#### DIMENSIONS, MM

Pitch teeth, p	2,032
Estimated length	471,420
Width, W	7,874
Height, H	1,140
C	40,000
h2	0,510
A	1,140
Number of teeth	232

**MANUFACTURER** [SKF](#)