

PHG 70-XL-031 SKF

Classical timing belt

TYPE: Classical timing belts, Oneway, Classical, Section XL (SKF)

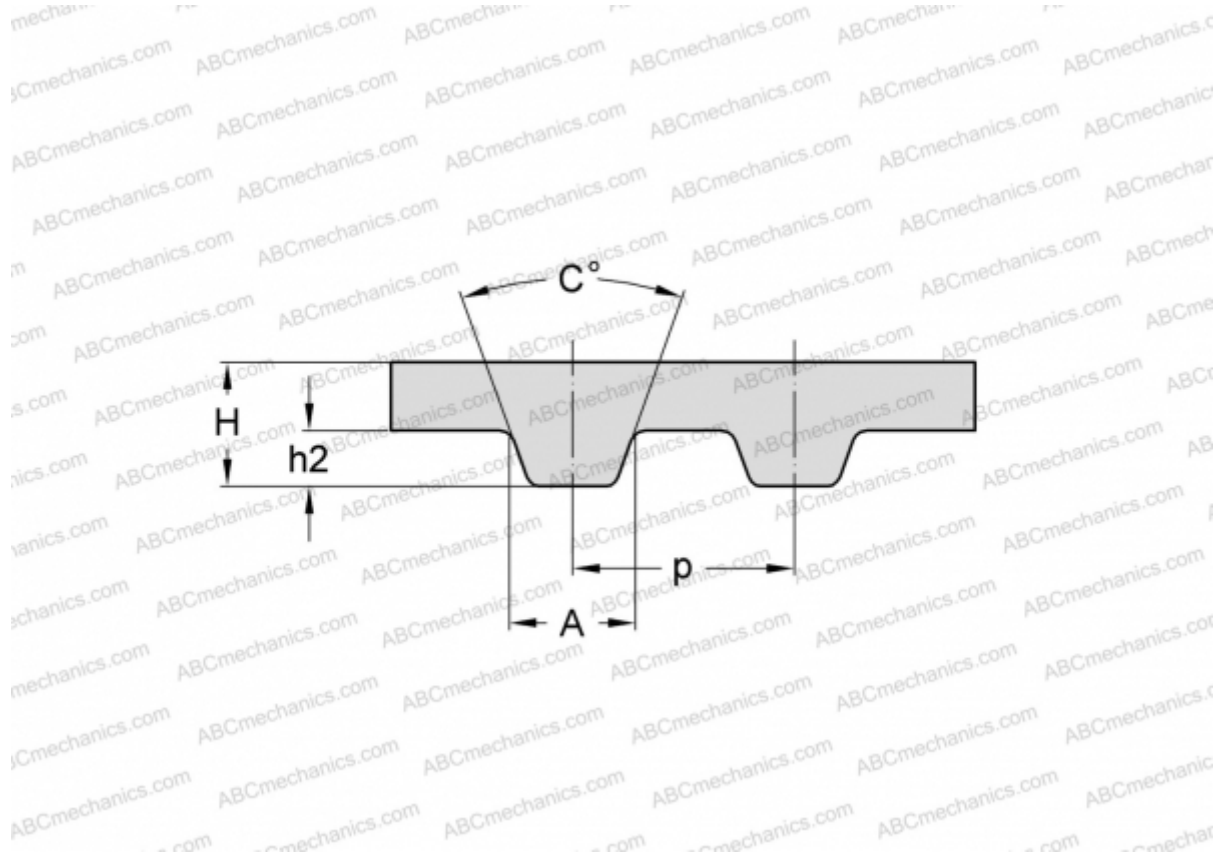

Technical specification

DIMENSIONS, MM

| | |
|------------------|---------|
| Pitch teeth, p | 5,080 |
| Estimated length | 177,800 |
| Width, W | 7,874 |
| Height, H | 2,300 |
| C | 50,000 |
| h2 | 1,270 |
| A | 2,570 |
| Number of teeth | 35 |

MANUFACTURER

[SKF](#)