

## PHG 94-XL-025 SKF

Classical timing belt

TYPE: Classical timing belts, Oneway, Classical, Section XL (SKF)

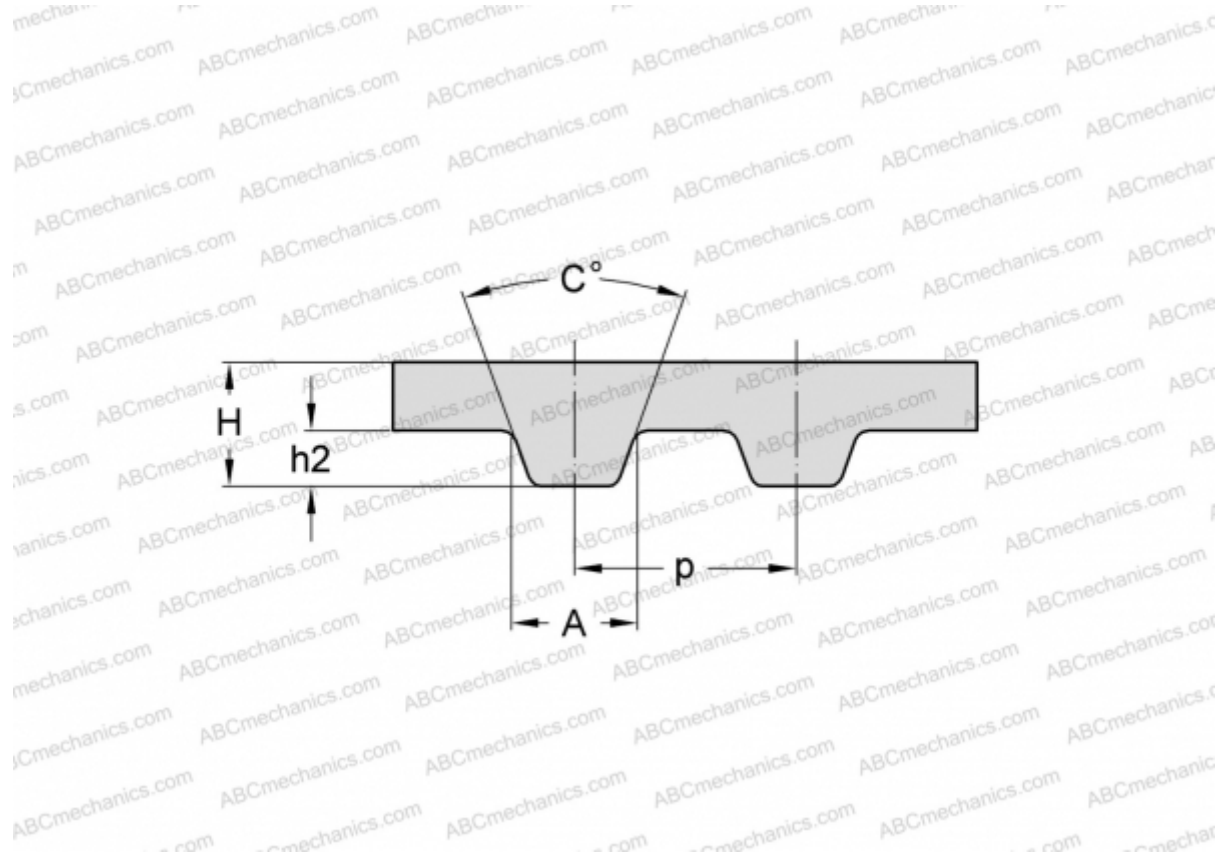

### Technical specification

#### DIMENSIONS, MM

Pitch teeth, p	5,080
Estimated length	238,760
Width, W	6,350
Height, H	2,300
C	50,000
h2	1,270
A	2,570
Number of teeth	47

#### MANUFACTURER

[SKF](#)