

PHG 132-XL-031 SKF

Classical timing belt

TYPE: Classical timing belts, Oneway, Classical, Section XL (SKF)

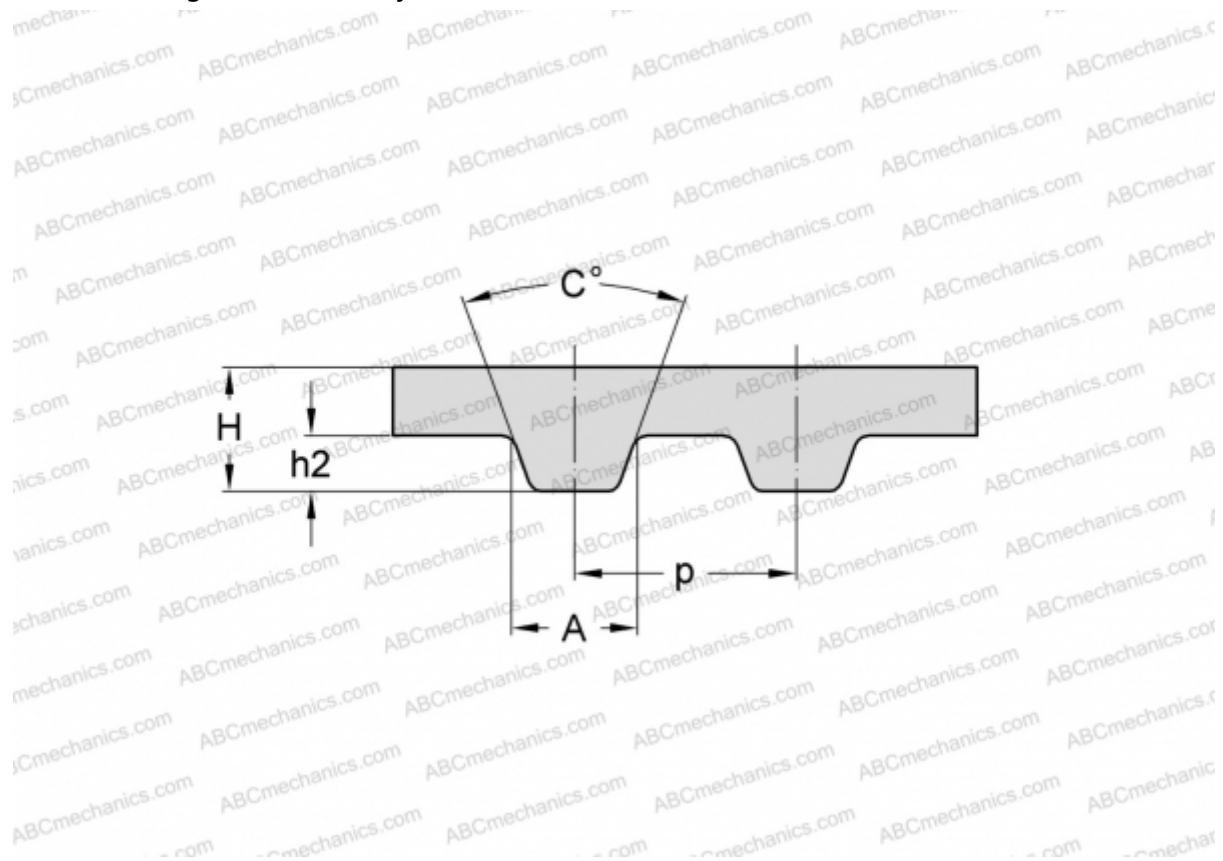

Technical specification

DIMENSIONS, MM

Pitch teeth, p	5,080
Estimated length	335,280
Width, W	7,874
Height, H	2,300
C	50,000
h2	1,270
A	2,570
Number of teeth	66

MANUFACTURER

[SKF](#)