

PHG 178-XL-025 SKF

Classical timing belt

TYPE: Classical timing belts, Oneway, Classical, Section XL (SKF)

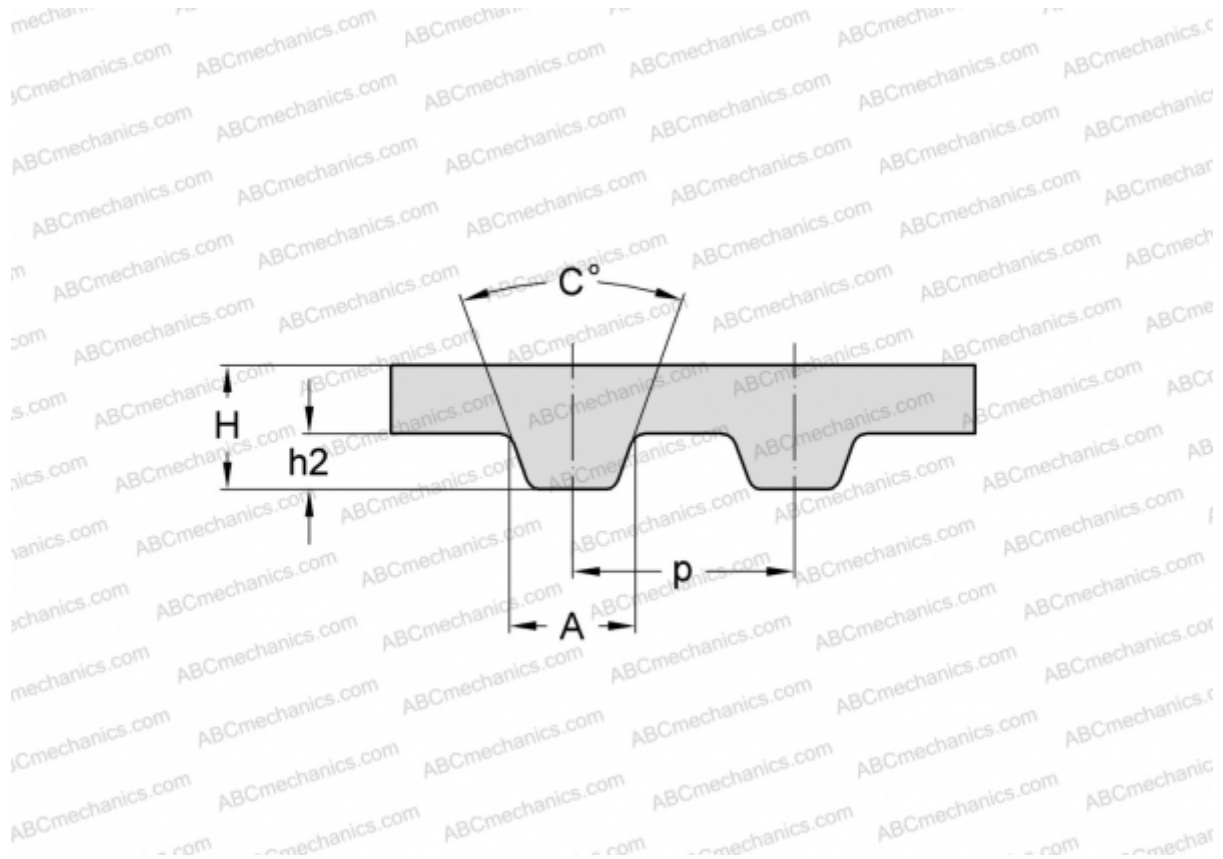

Technical specification

DIMENSIONS, MM

Pitch teeth, p	5,080
Estimated length	452,120
Width, W	6,350
Height, H	2,300
C	50,000
h2	1,270
A	2,570
Number of teeth	89

MANUFACTURER

[SKF](#)