

## PHG 384-XL-037 SKF

Classical timing belt

TYPE: Classical timing belts, Oneway, Classical, Section XL (SKF)

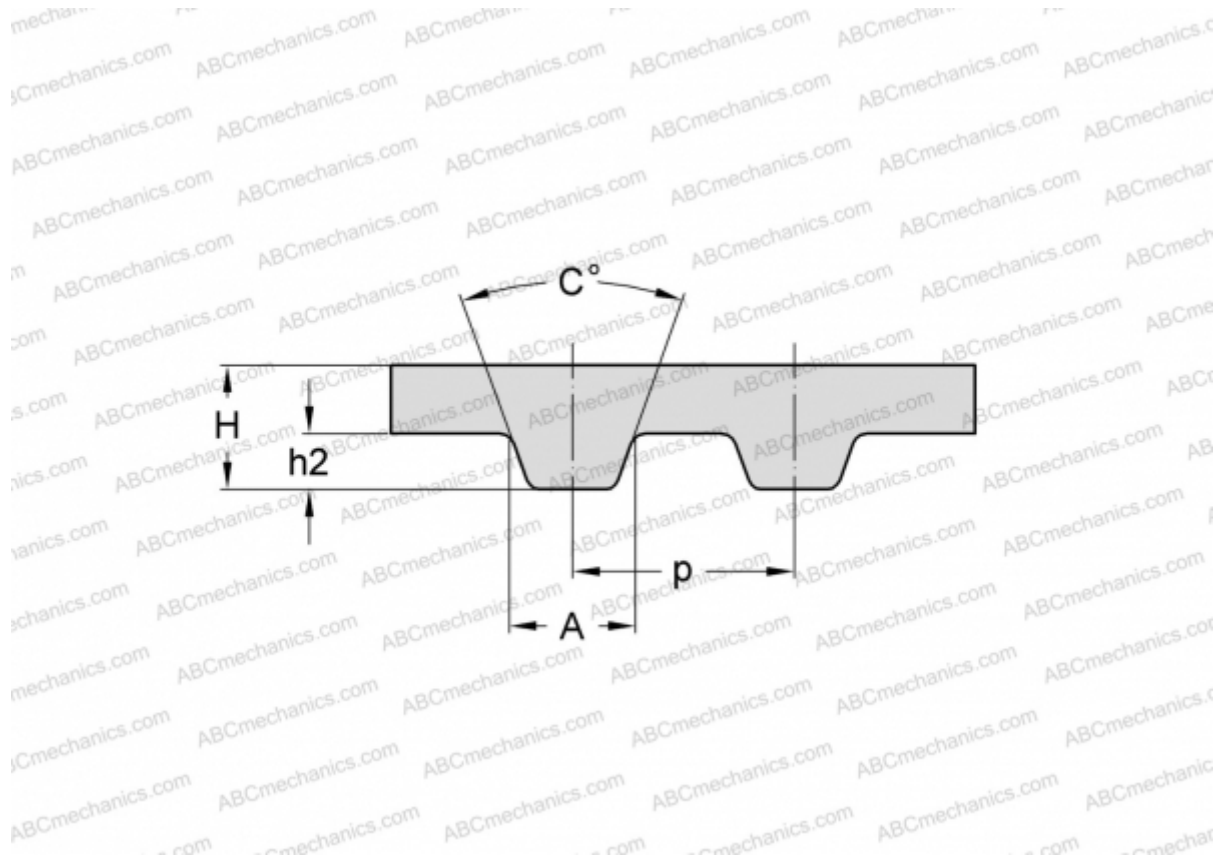

### Technical specification

#### DIMENSIONS, MM

Pitch teeth, p	5,080
Estimated length	975,360
Width, W	9,398
Height, H	2,300
C	50,000
h2	1,270
A	2,570
Number of teeth	192

**MANUFACTURER** [SKF](#)