

## PHG 304-L-0100 SKF

Classical timing belt

TYPE: Classical timing belts, Oneway, Classical, Section L (SKF)

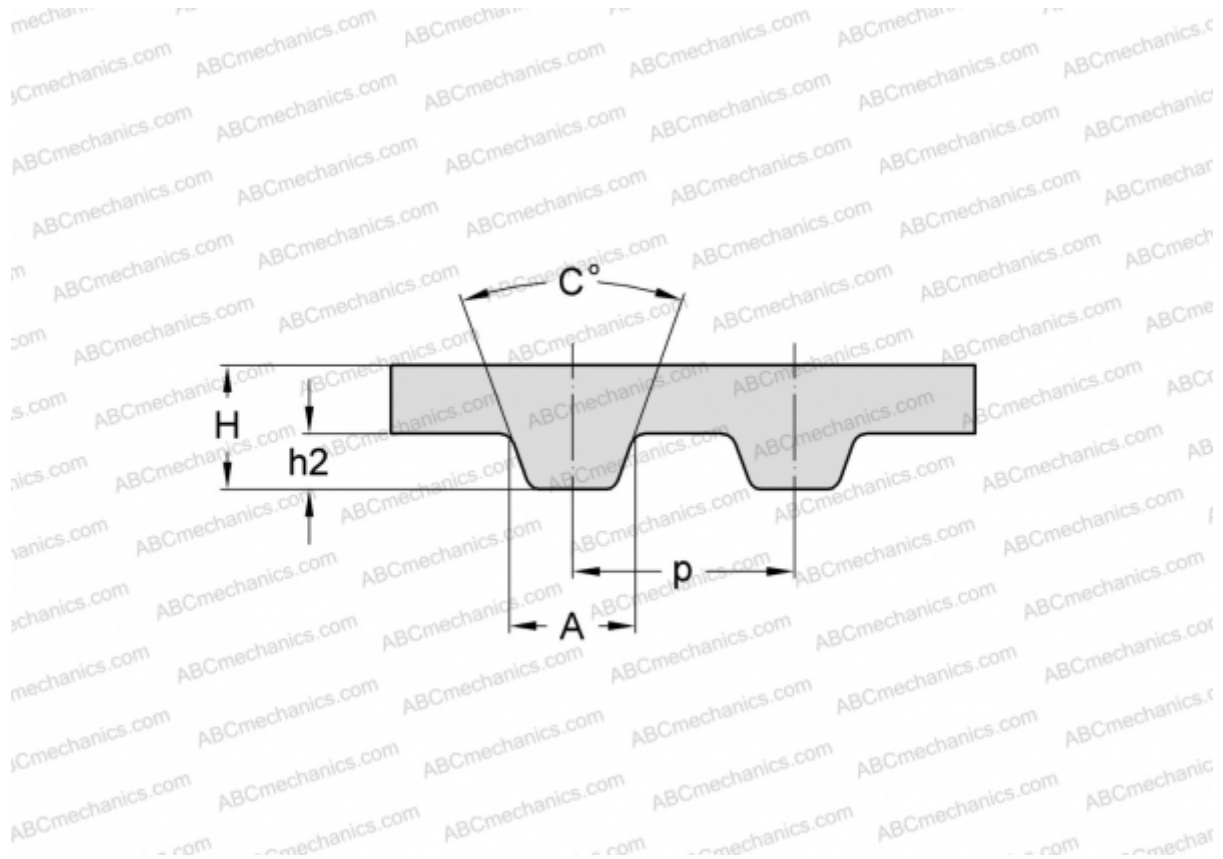

### Technical specification

#### DIMENSIONS, MM

Pitch teeth, p	9,525
Estimated length	771,530
Width, W	25,400
Height, H	3,600
C	40,000
h2	1,910
A	4,650
Number of teeth	81

#### MANUFACTURER

[SKF](#)