

PHG 450-L-050 SKF

Classical timing belt

TYPE: Classical timing belts, Oneway, Classical, Section L (SKF)

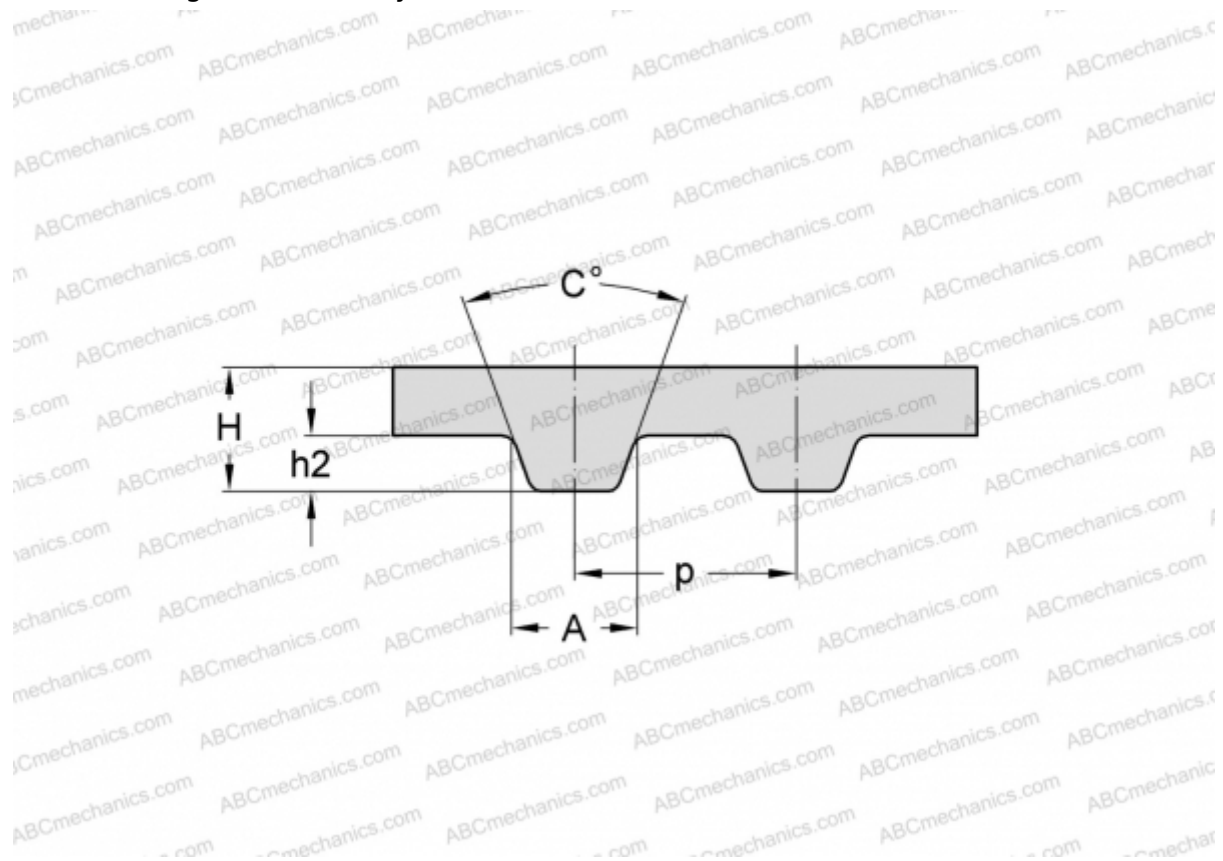

Technical specification

DIMENSIONS, MM

Pitch teeth, p	9,525
Estimated length	1143,000
Width, W	12,700
Height, H	3,600
C	40,000
h2	1,910
A	4,650
Number of teeth	120

MANUFACTURER [SKF](#)