

PHG 510-L-075 SKF

Classical timing belt

TYPE: Classical timing belts, Oneway, Classical, Section L (SKF)

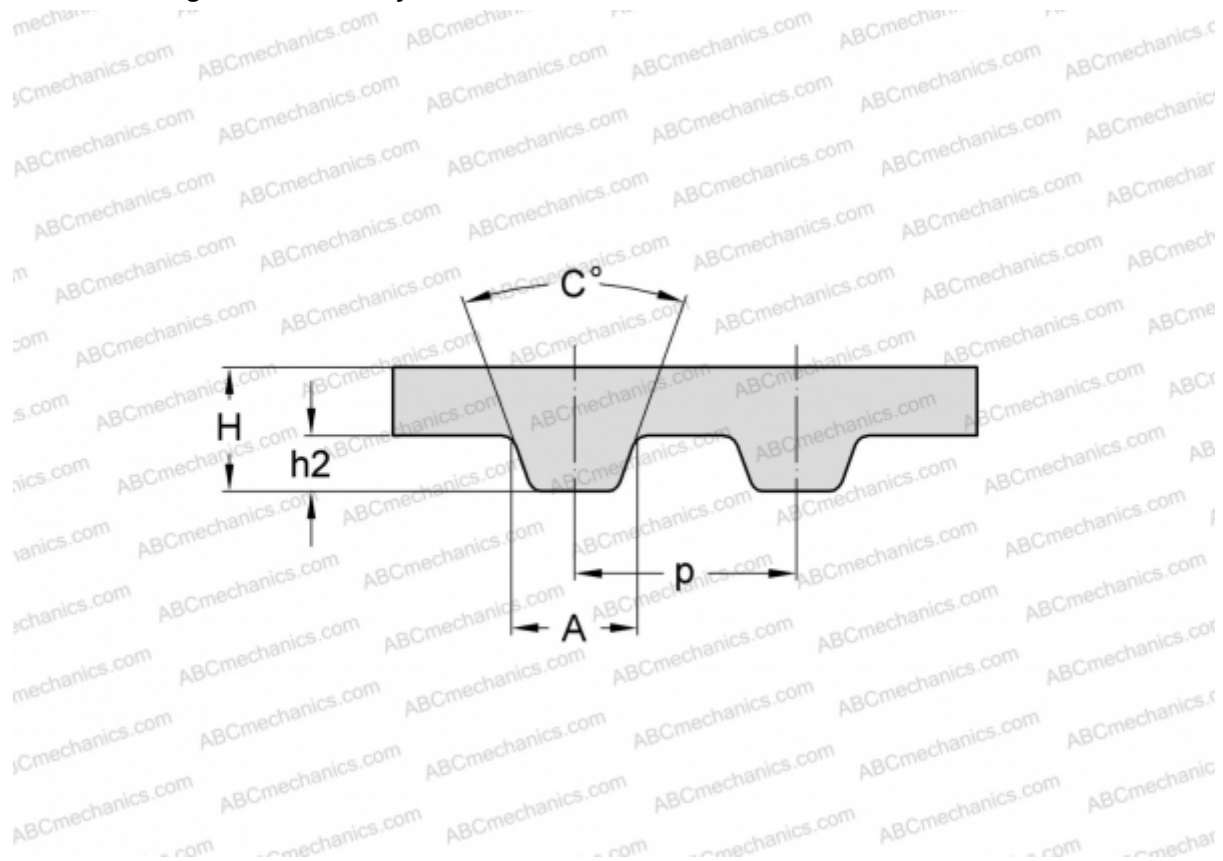

Technical specification

DIMENSIONS, MM

Pitch teeth, p	9,525
Estimated length	1295,400
Width, W	19,050
Height, H	3,600
C	40,000
h_2	1,910
A	4,650
Number of teeth	136

MANUFACTURER [SKF](#)