

PHG 630-H-200 SKF

Classical timing belt

TYPE: Classical timing belts, Oneway, Classical, Section H (SKF)

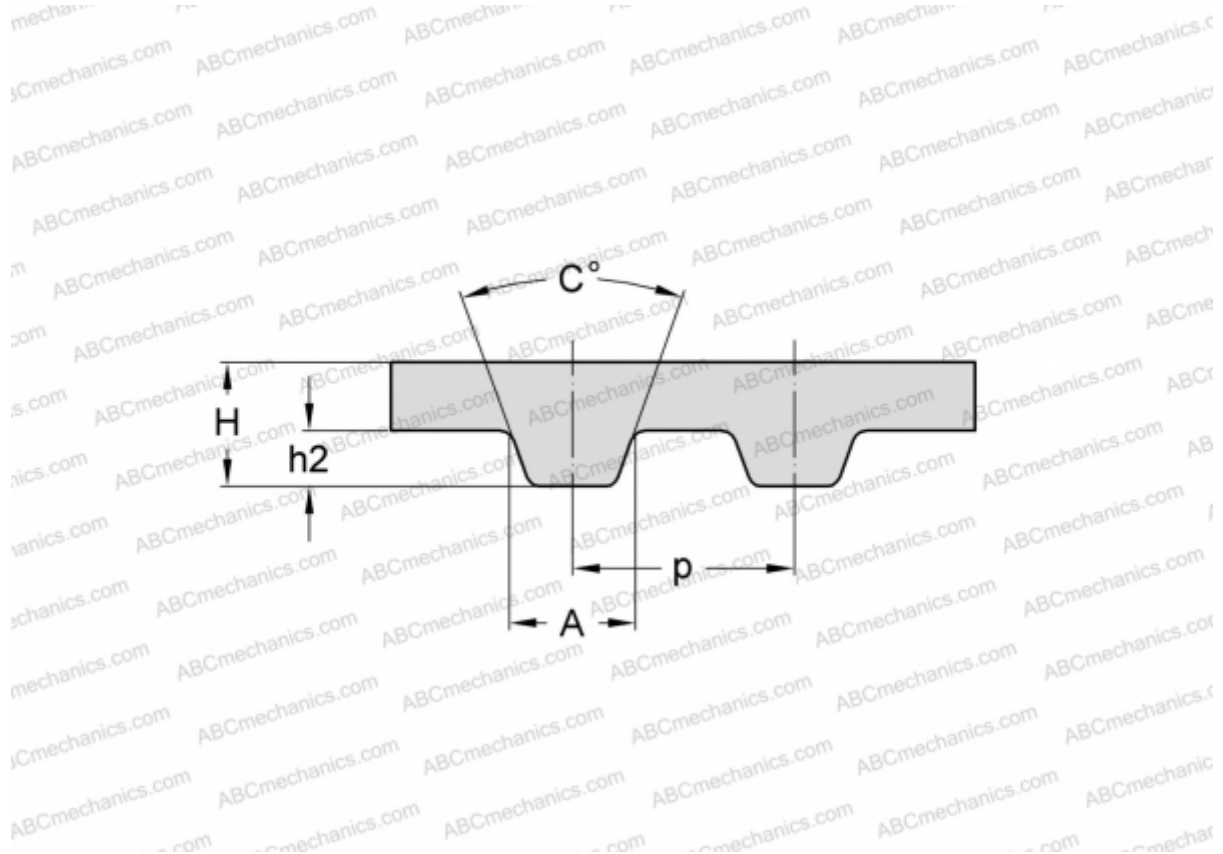

Technical specification

DIMENSIONS, MM

Pitch teeth, p	12,700
Estimated length	1600,200
Width, W	50,800
Height, H	4,300
C	40,000
h2	2,290
A	6,120
Number of teeth	126

MANUFACTURER [SKF](#)