

PHG 1050-H-100 SKF

Classical timing belt

TYPE: Classical timing belts, Oneway, Classical, Section H (SKF)

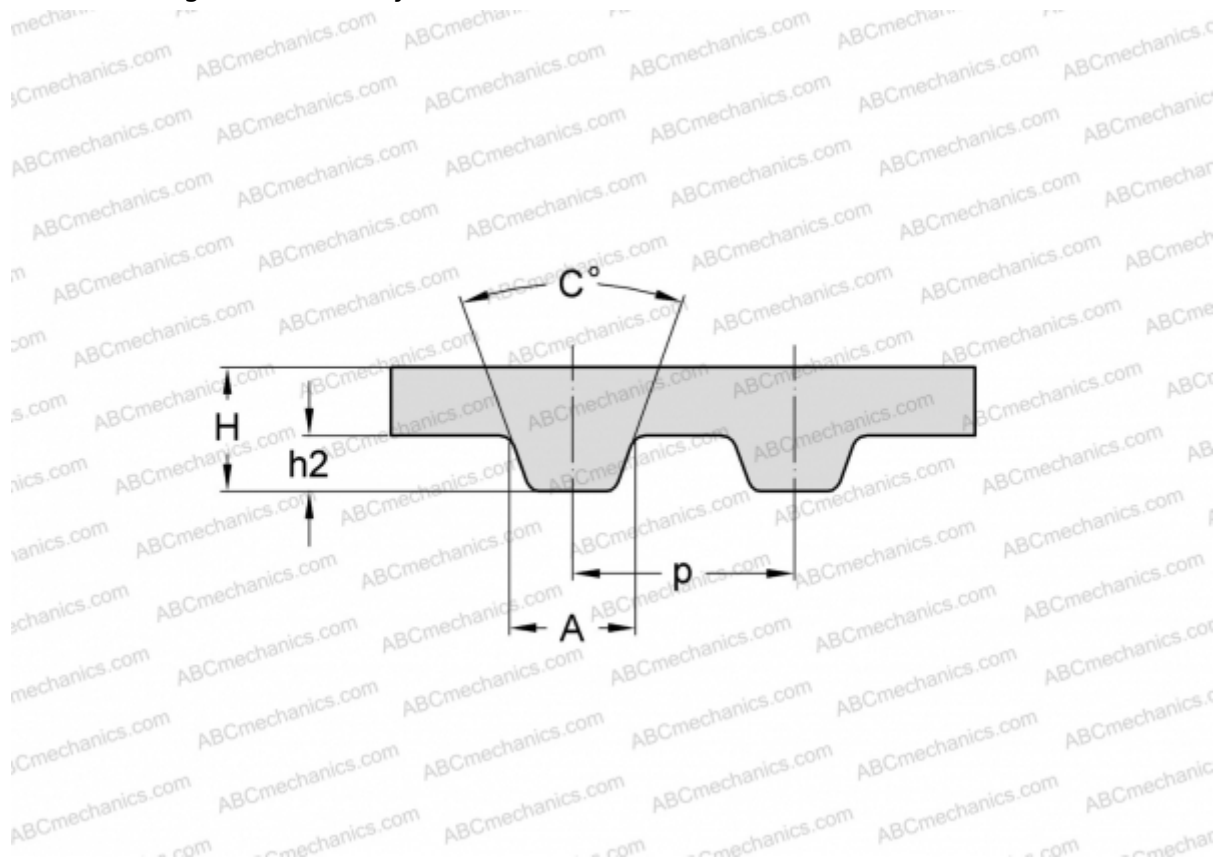

Technical specification

DIMENSIONS, MM

| | |
|------------------|----------|
| Pitch teeth, p | 12,700 |
| Estimated length | 2667,000 |
| Width, W | 25,400 |
| Height, H | 4,300 |
| C | 40,000 |
| h2 | 2,290 |
| A | 6,120 |
| Number of teeth | 210 |

MANUFACTURER [SKF](#)