

PHG 1250-H-300 SKF

Classical timing belt

TYPE: Classical timing belts, Oneway, Classical, Section H (SKF)

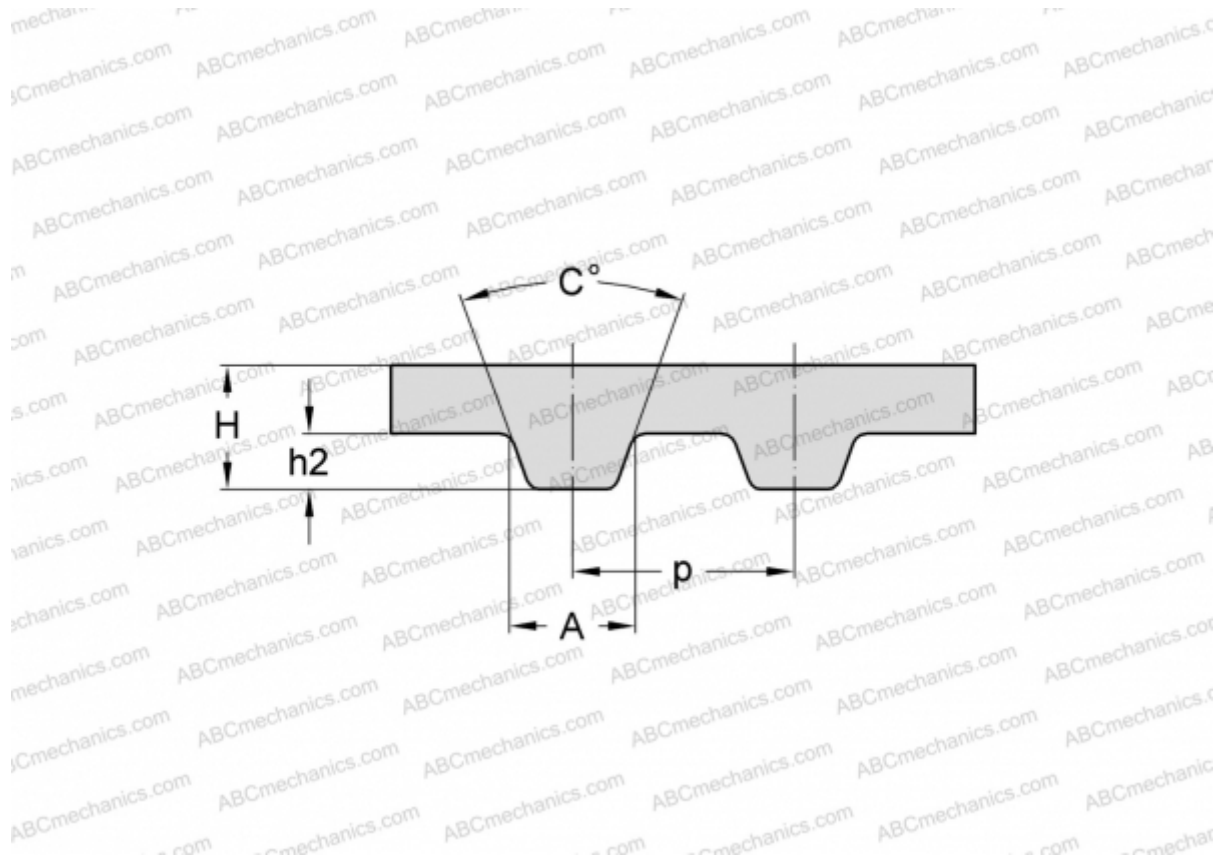

Technical specification

DIMENSIONS, MM

Pitch teeth, p	12,700
Estimated length	3175,000
Width, W	76,200
Height, H	4,300
C	40,000
h2	2,290
A	6,120
Number of teeth	250

MANUFACTURER

[SKF](#)