

## PHG 2600-H-100 SKF

Classical timing belt

TYPE: Classical timing belts, Oneway, Classical, Section H (SKF)

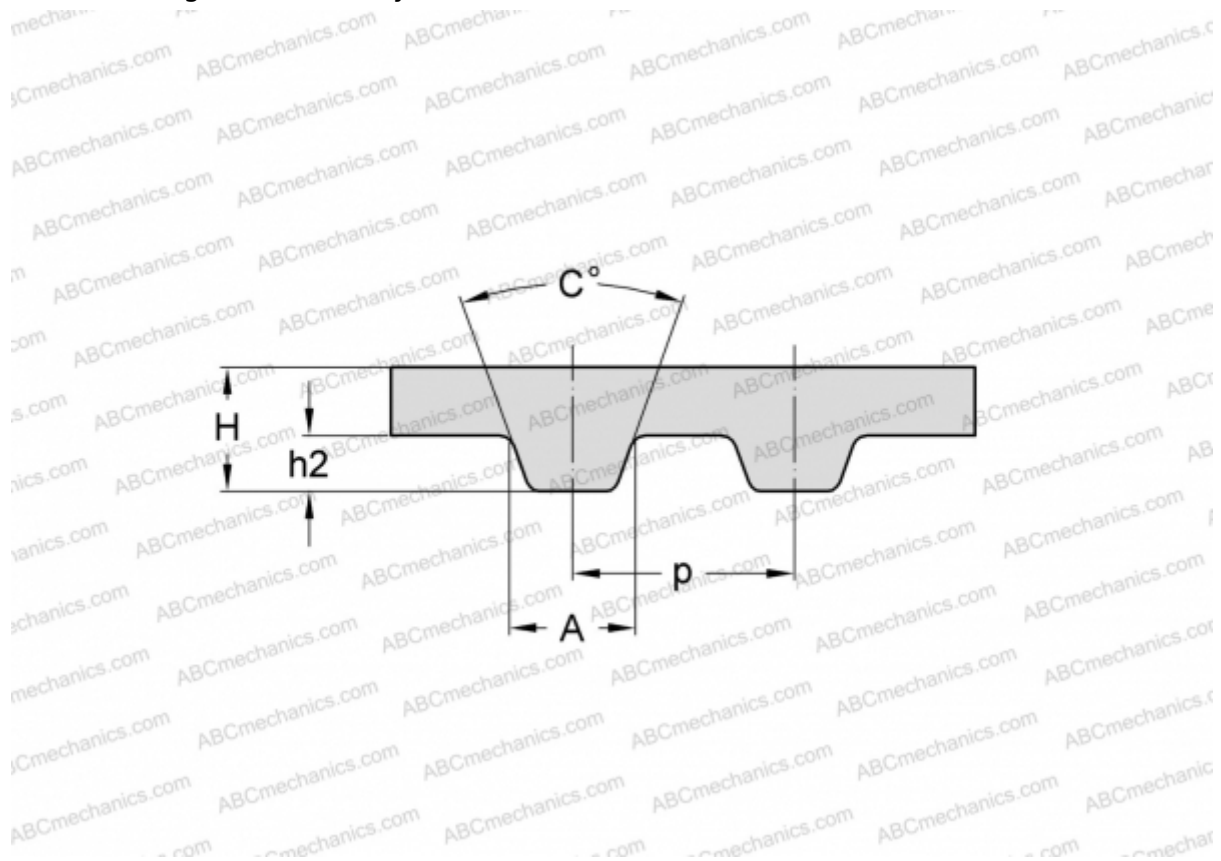

### Technical specification

#### DIMENSIONS, MM

Pitch teeth, p	12,700
Estimated length	6604,000
Width, W	25,400
Height, H	4,300
C	40,000
h2	2,290
A	6,120
Number of teeth	520

**MANUFACTURER** [SKF](#)