

PHG 463-XH-300 SKF

Classical timing belt

TYPE: Classical timing belts, Oneway, Classical, Section XH (SKF)

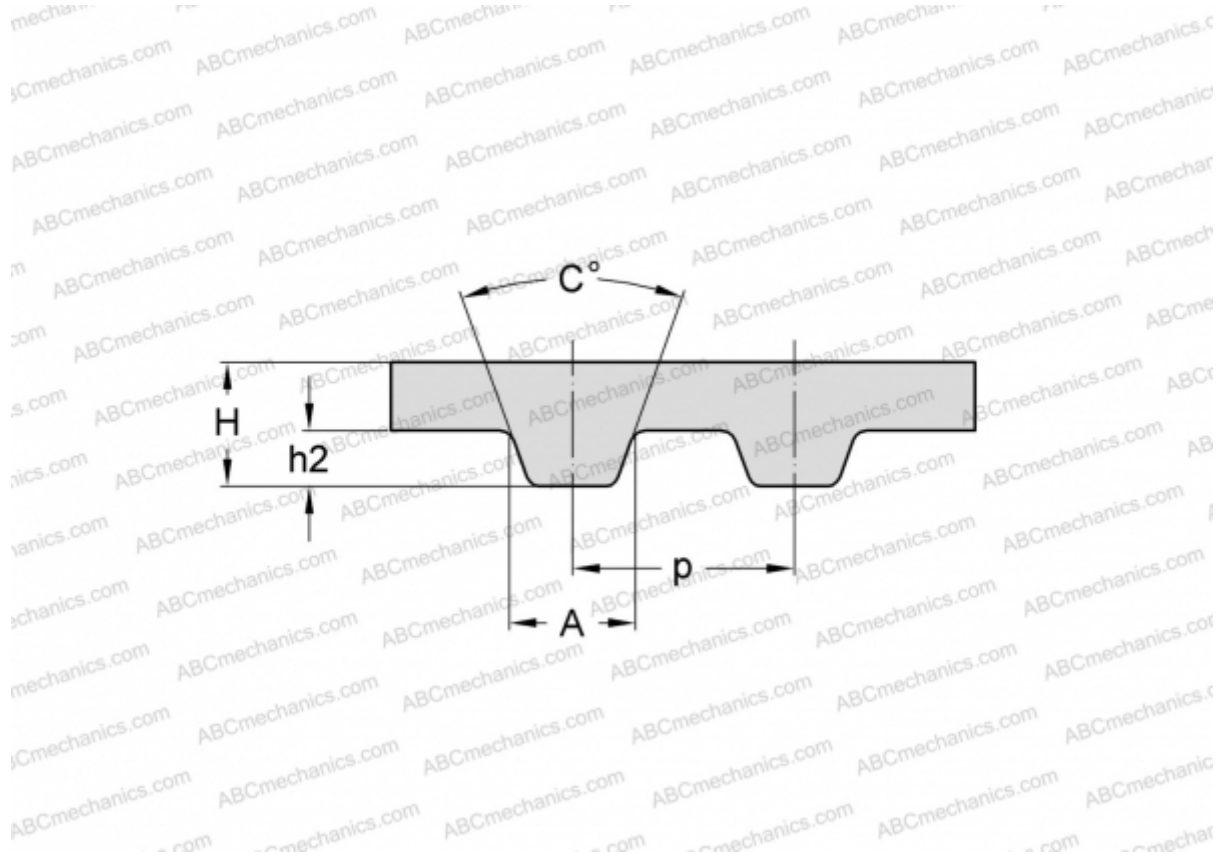

Technical specification

DIMENSIONS, MM

Pitch teeth, p	22,225
Estimated length	1117,930
Width, W	76,200
Height, H	11,200
C	40,000
h2	6,350
A	12,570
Number of teeth	53

MANUFACTURER

[SKF](#)