

## PHG 630-XH-300 SKF

Classical timing belt

TYPE: Classical timing belts, Oneway, Classical, Section XH (SKF)

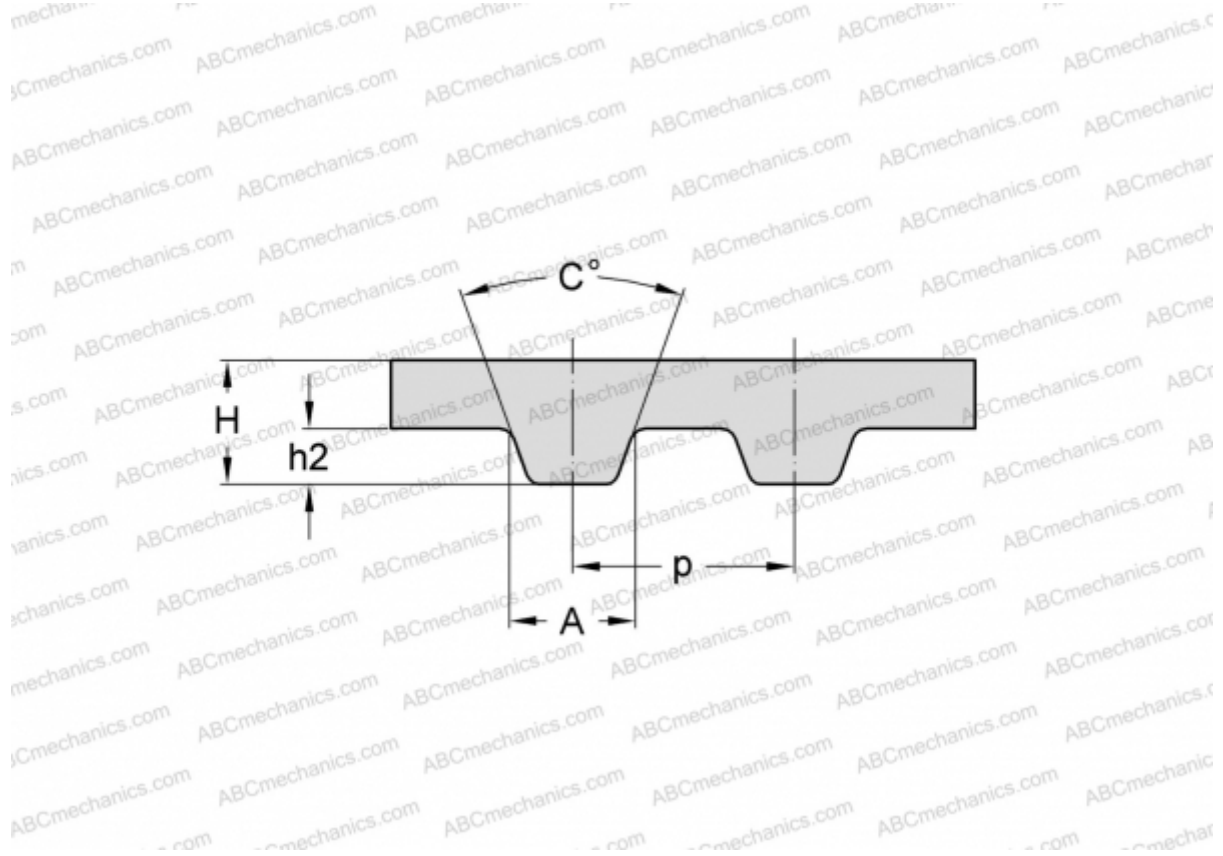

### Technical specification

#### DIMENSIONS, MM

Pitch teeth, p	22,225
Estimated length	1600,200
Width, W	76,200
Height, H	11,200
C	40,000
h2	6,350
A	12,570
Number of teeth	72

#### MANUFACTURER

[SKF](#)