

PHG 1250-XXH-400 SKF

Classical timing belt

TYPE: Classical timing belts, Oneway, Classical, Section XXH (SKF)

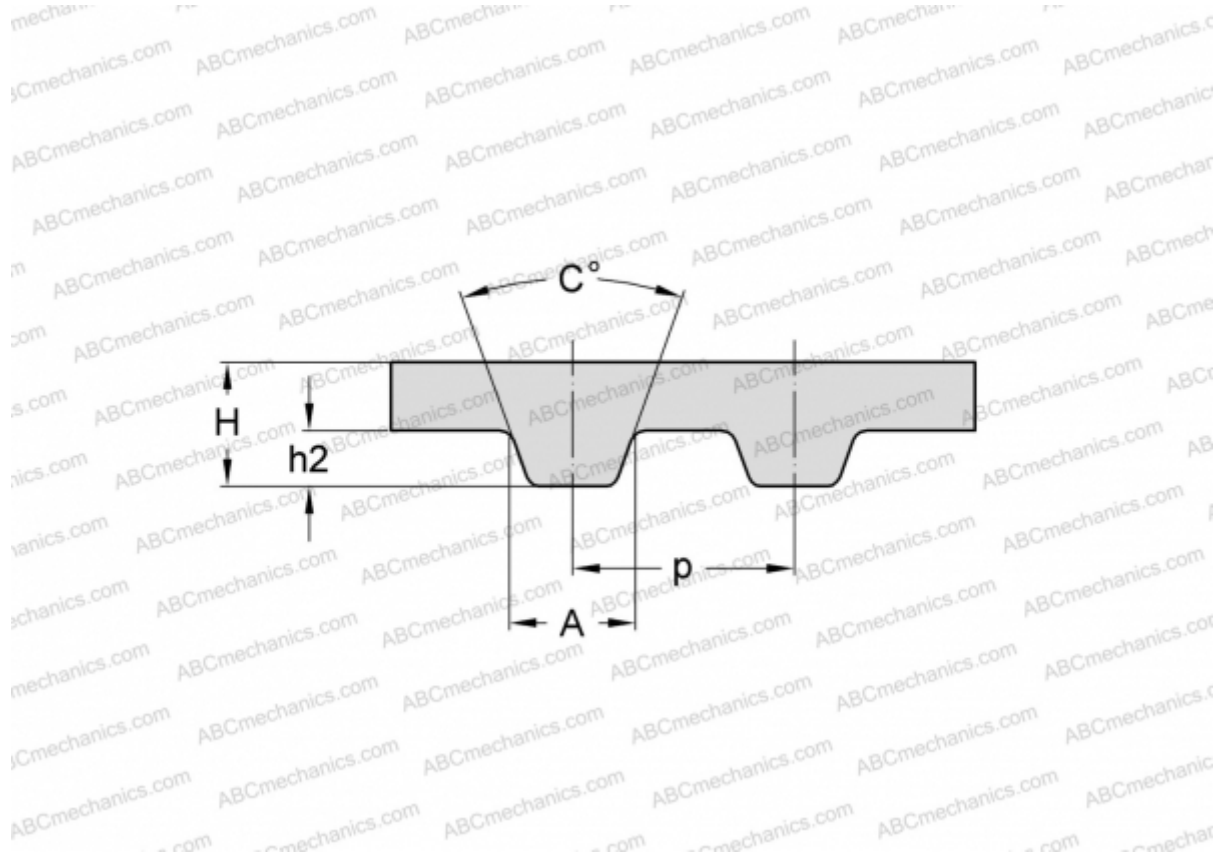

Technical specification

DIMENSIONS, MM

Pitch teeth, p	31,750
Estimated length	3175,000
Width, W	101,600
Height, H	15,700
C	40,000
h2	9,530
A	19,050
Number of teeth	100

MANUFACTURER

[SKF](#)