

## PHG 384-3M-15 SKF

HiTD belt

TYPE: Classical timing belts, Oneway, HiTD, Section 3M (SKF)

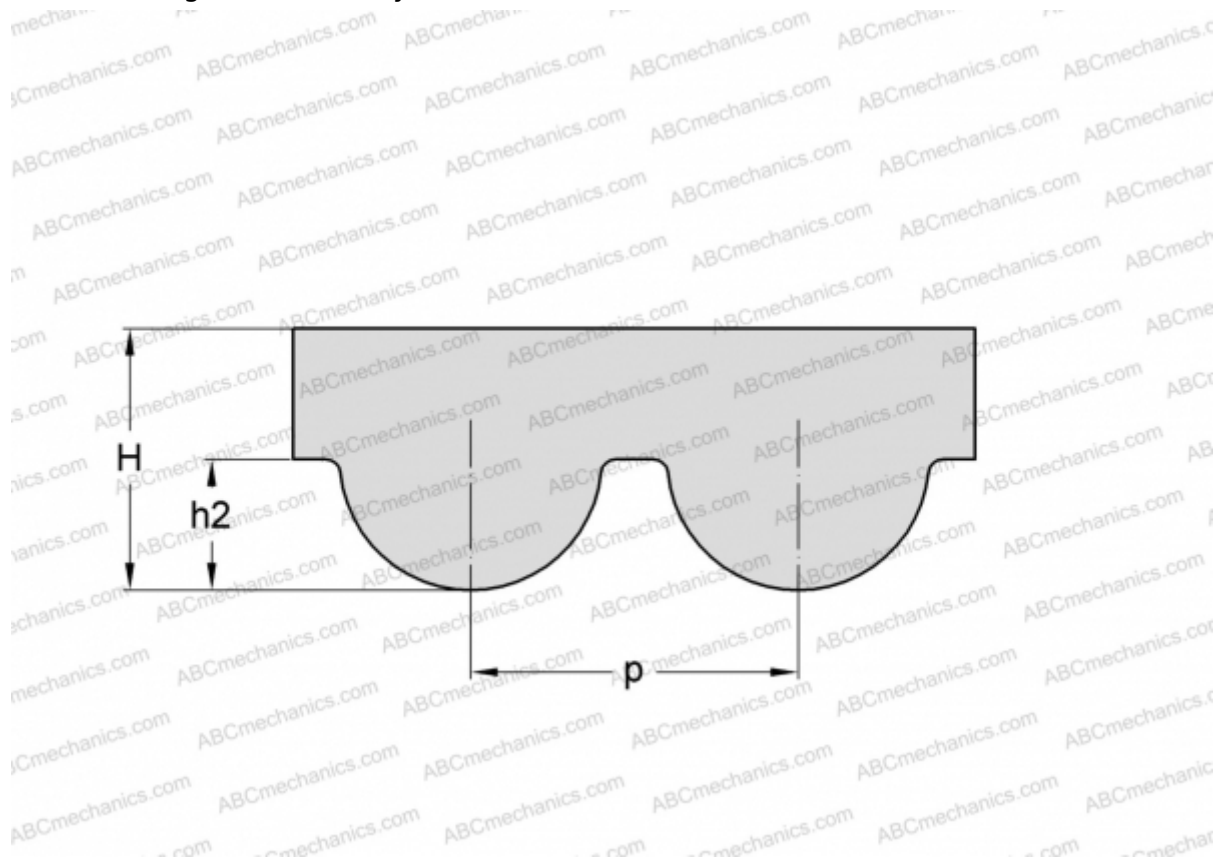

### Technical specification

#### DIMENSIONS, MM

Pitch teeth, p	3,000
Estimated length	384,000
Width, W	15,000
Height, H	2,400
h2	1,200
Number of teeth	128

#### MANUFACTURER

[SKF](#)