

PHG 390-3M-15 SKF

HiTD belt

TYPE: Classical timing belts, Oneway, HiTD, Section 3M (SKF)

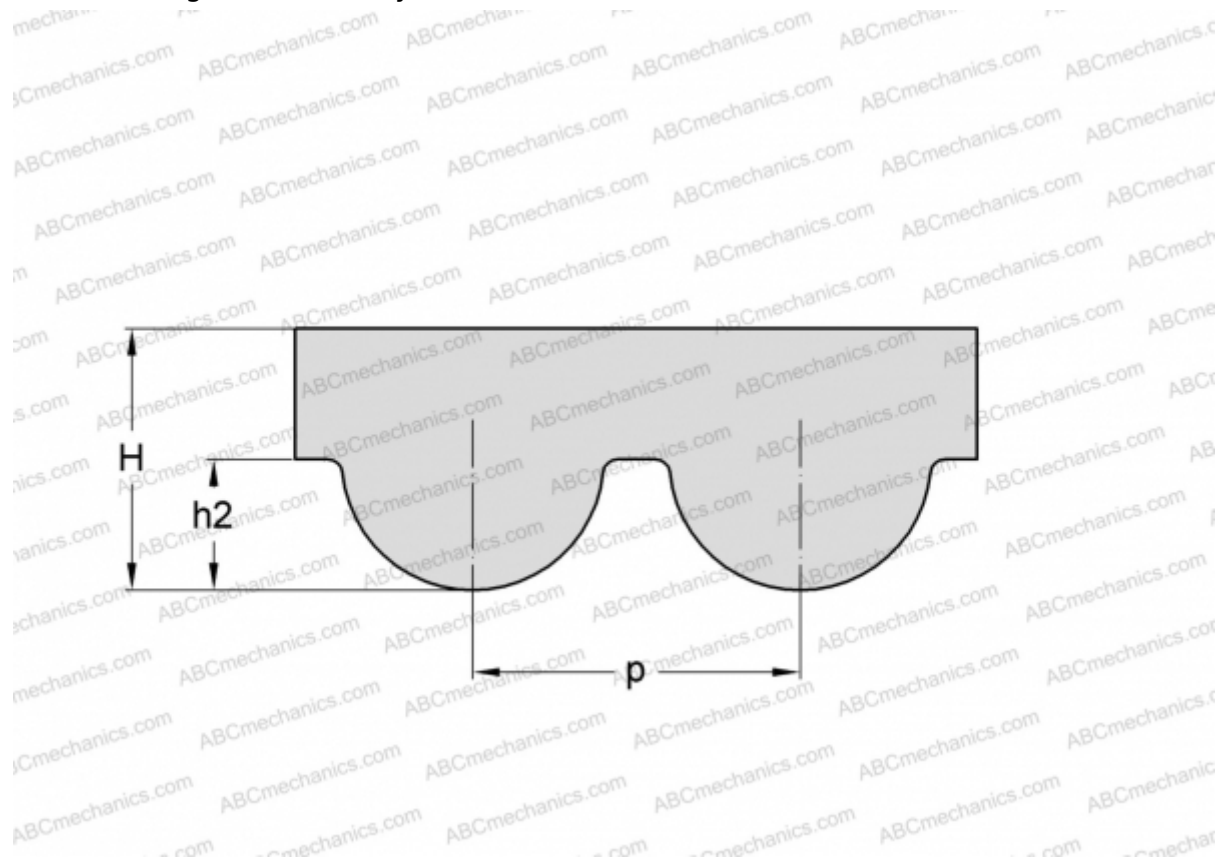

Technical specification

DIMENSIONS, MM

Pitch teeth, p	3,000
Estimated length	390,000
Width, W	15,000
Height, H	2,400
h2	1,200
Number of teeth	130

MANUFACTURER

[SKF](#)