

## PHG 531-3M-9 SKF

HiTD belt

TYPE: Classical timing belts, Oneway, HiTD, Section 3M (SKF)

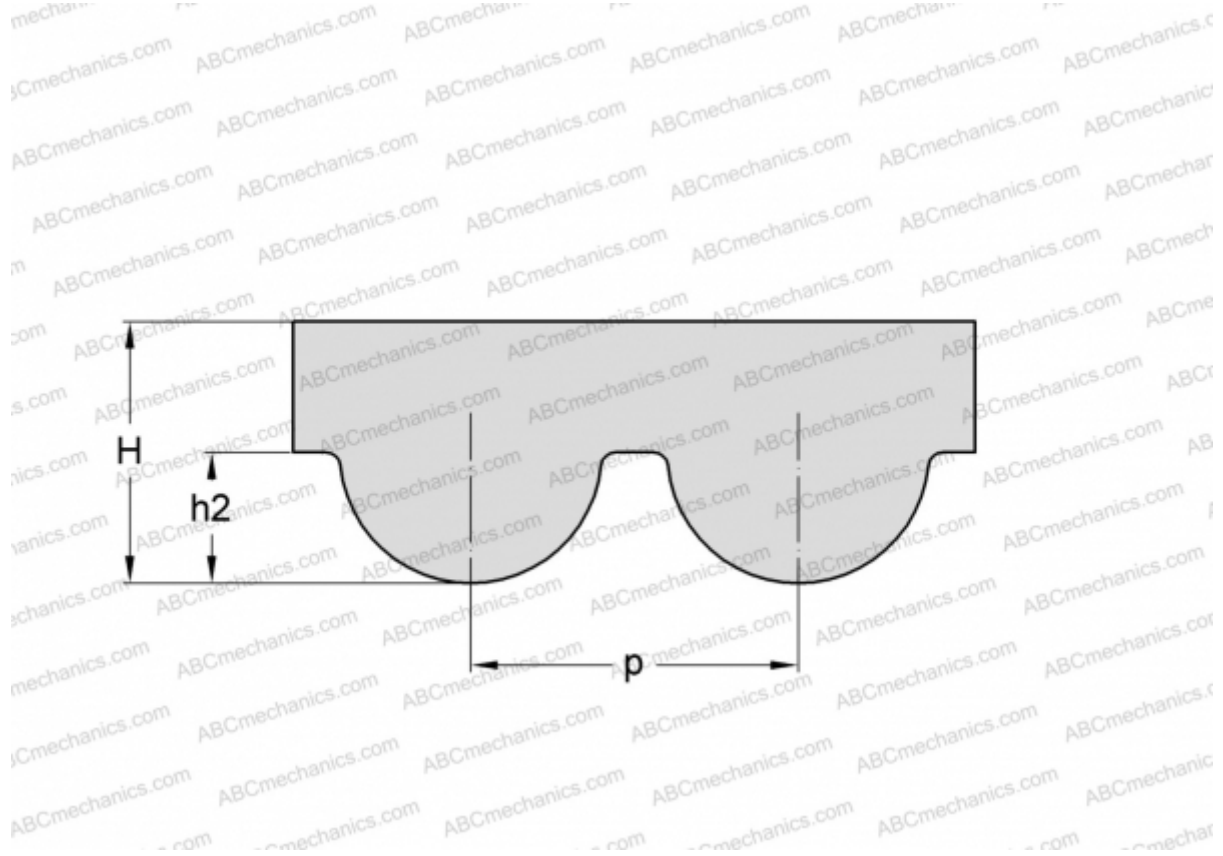

### Technical specification

#### DIMENSIONS, MM

Pitch teeth, $p$	3,000
Estimated length	531,000
Width, $W$	9,000
Height, $H$	2,400
$h_2$	1,200
Number of teeth	177

#### MANUFACTURER

[SKF](#)