

## PHG 3390-3M-9 SKF

HiTD belt

TYPE: Classical timing belts, Oneway, HiTD, Section 3M (SKF)

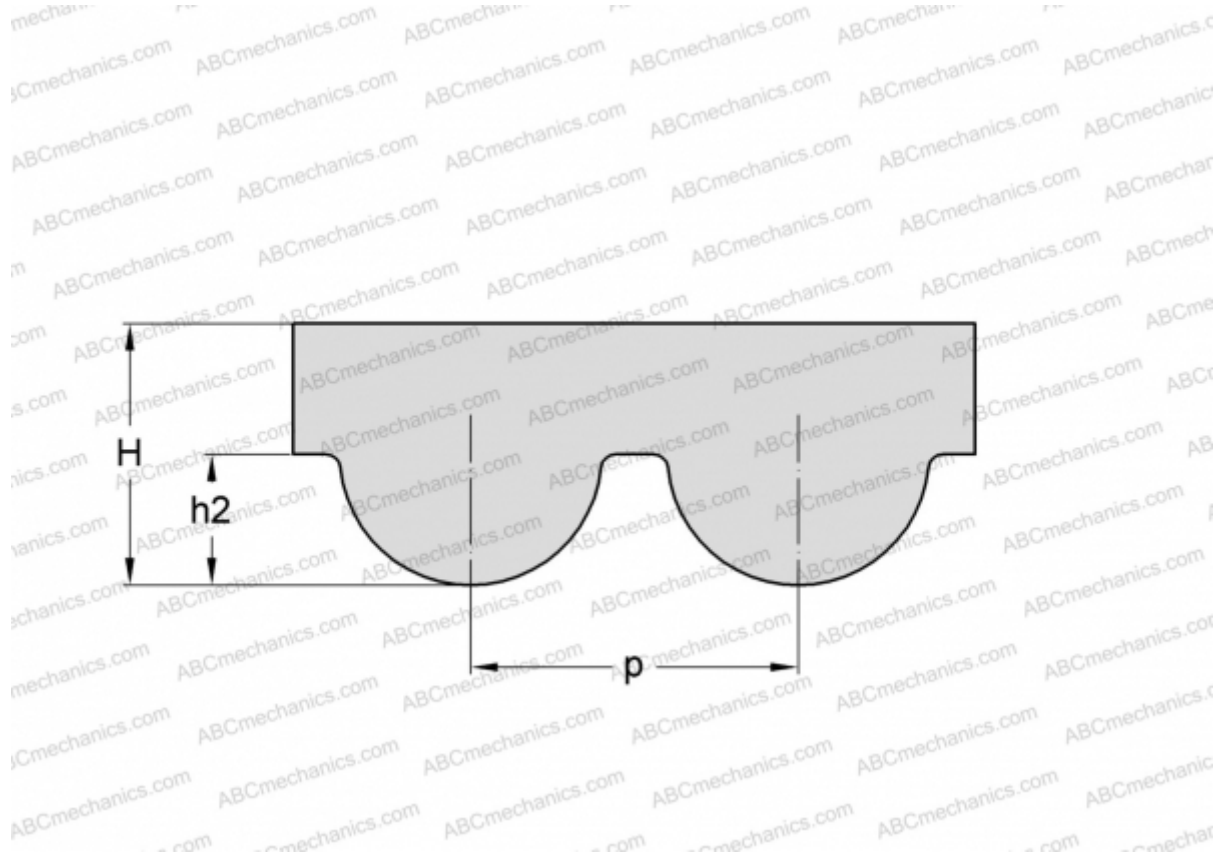

### Technical specification

#### DIMENSIONS, MM

Pitch teeth, p	3,000
Estimated length	3390,000
Width, W	9,000
Height, H	2,400
h2	1,200
Number of teeth	1130

#### MANUFACTURER

[SKF](#)