

PHG 360-5M-15 SKF

HiTD belt

TYPE: Classical timing belts, Oneway, HiTD, Section 5M (SKF)

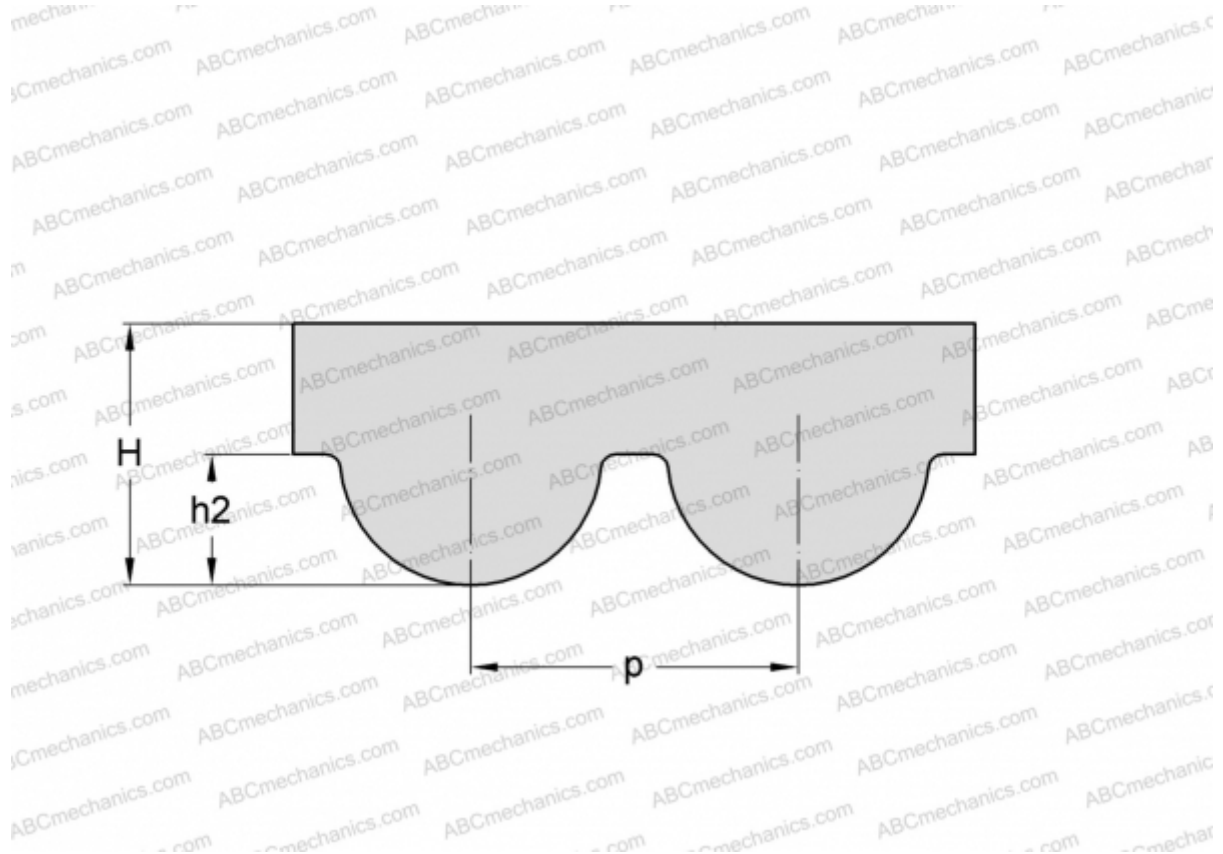

Technical specification

DIMENSIONS, MM

Pitch teeth, p	5,000
Estimated length	360,000
Width, W	15,000
Height, H	3,600
h_2	2,100
Number of teeth	72

MANUFACTURER

[SKF](#)