

PHG 740-5M-9 SKF

HiTD belt

TYPE: Classical timing belts, Oneway, HiTD, Section 5M (SKF)

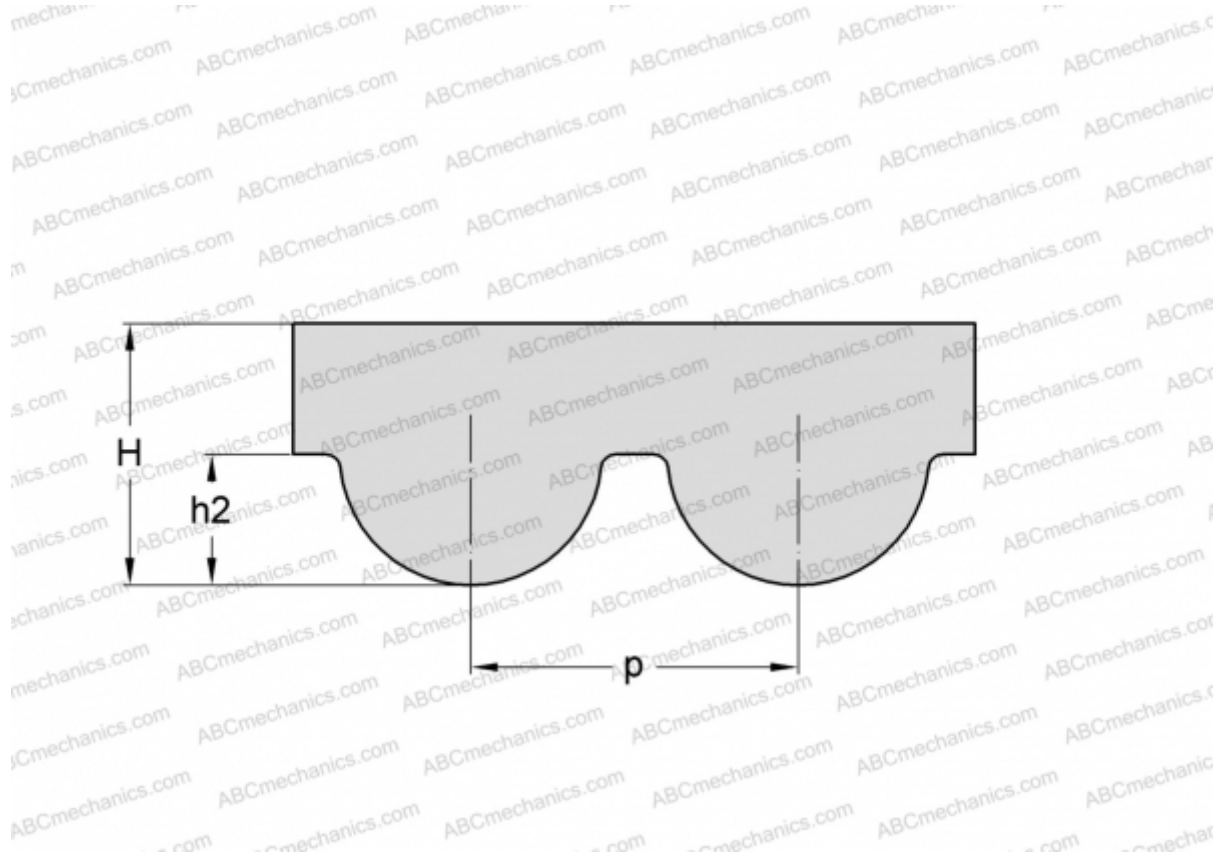

Technical specification

DIMENSIONS, MM

Pitch teeth, p	5,000
Estimated length	740,000
Width, W	9,000
Height, H	3,600
$h2$	2,100
Number of teeth	148

MANUFACTURER [SKF](#)