

## PHG 1210-5M-9 SKF

HiTD belt

TYPE: Classical timing belts, Oneway, HiTD, Section 5M (SKF)

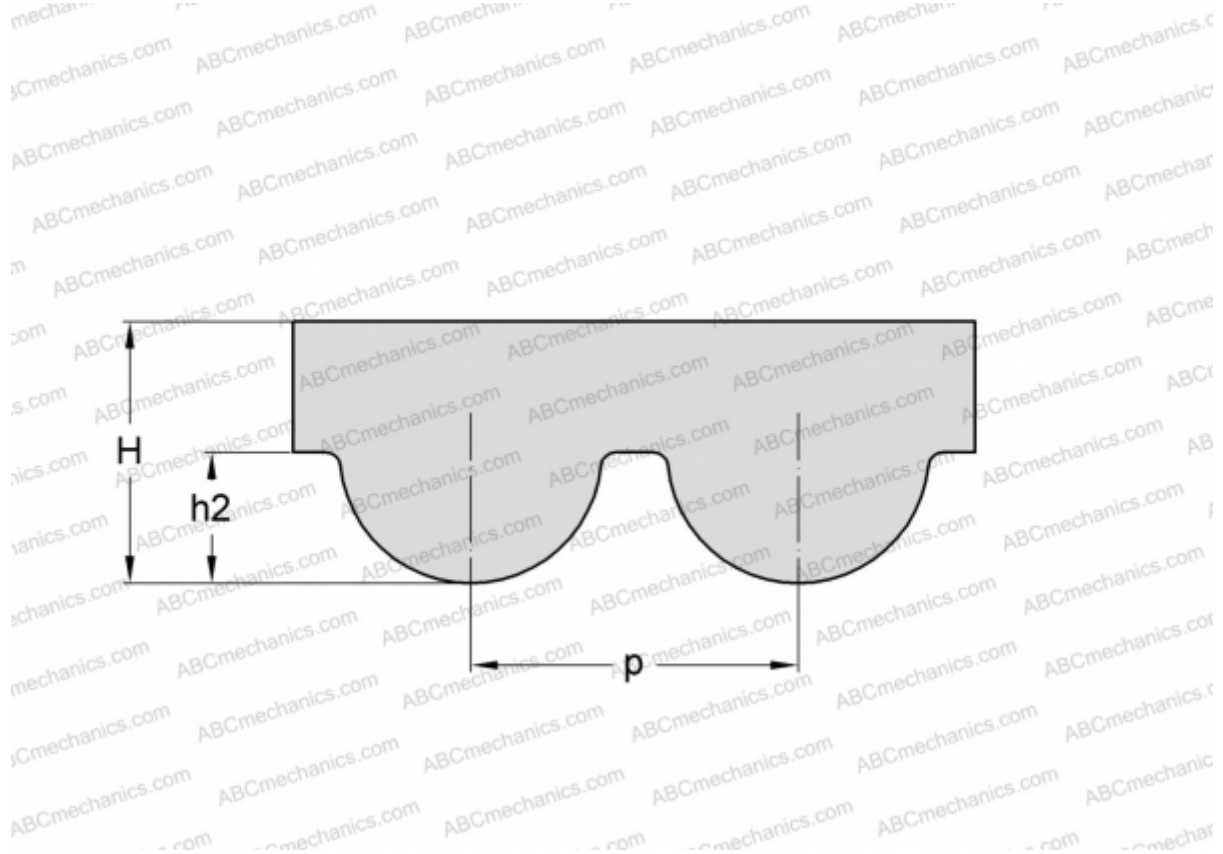

### Technical specification

#### DIMENSIONS, MM

Pitch teeth, p	5,000
Estimated length	1210,000
Width, W	9,000
Height, H	3,600
h2	2,100
Number of teeth	242

#### MANUFACTURER

[SKF](#)