

## PHG 1945-5M-9 SKF

HiTD belt

TYPE: Classical timing belts, Oneway, HiTD, Section 5M (SKF)

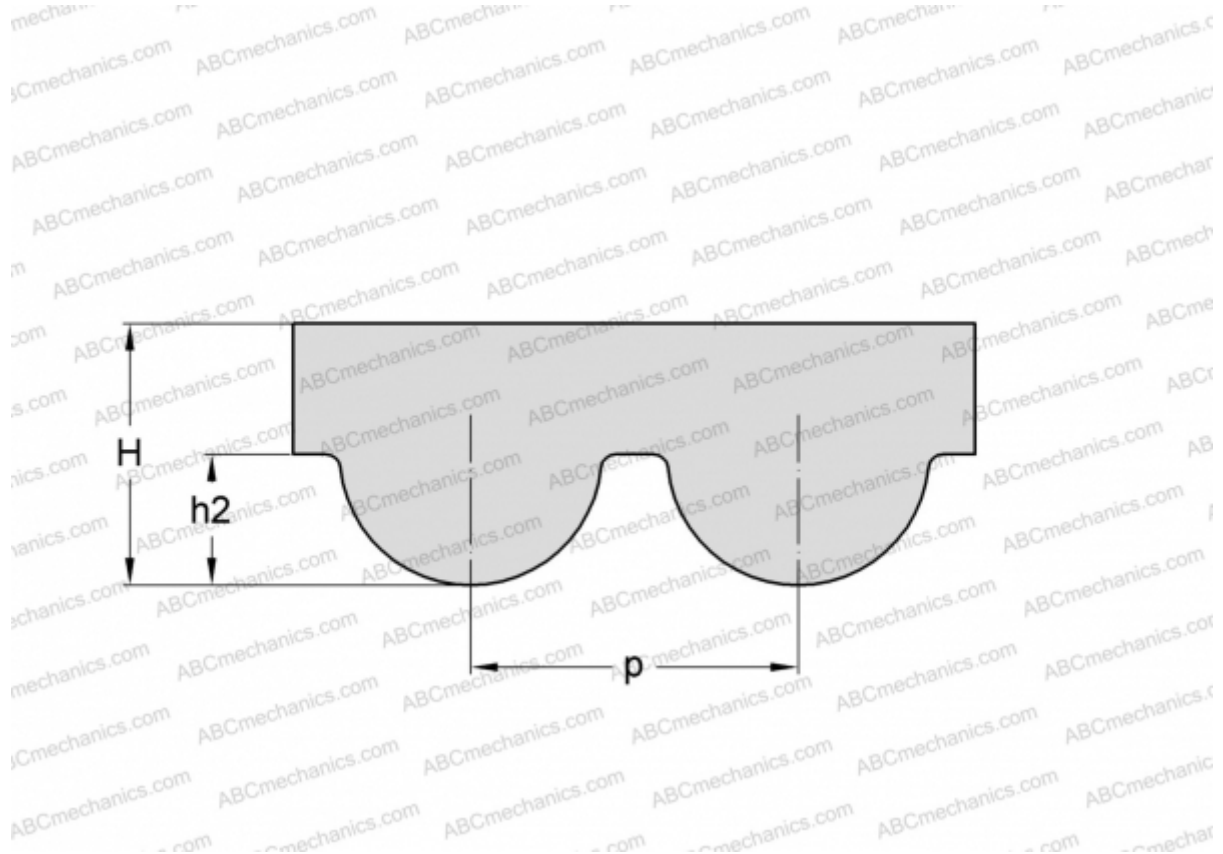

### Technical specification

#### DIMENSIONS, MM

Pitch teeth, $p$	5,000
Estimated length	1945,000
Width, $W$	9,000
Height, $H$	3,600
$h_2$	2,100
Number of teeth	389

#### MANUFACTURER

[SKF](#)