

## PHG 1016-8M-50 SKF

HiTD belt

TYPE: Classical timing belts, Oneway, HiTD, Section 8M (SKF)

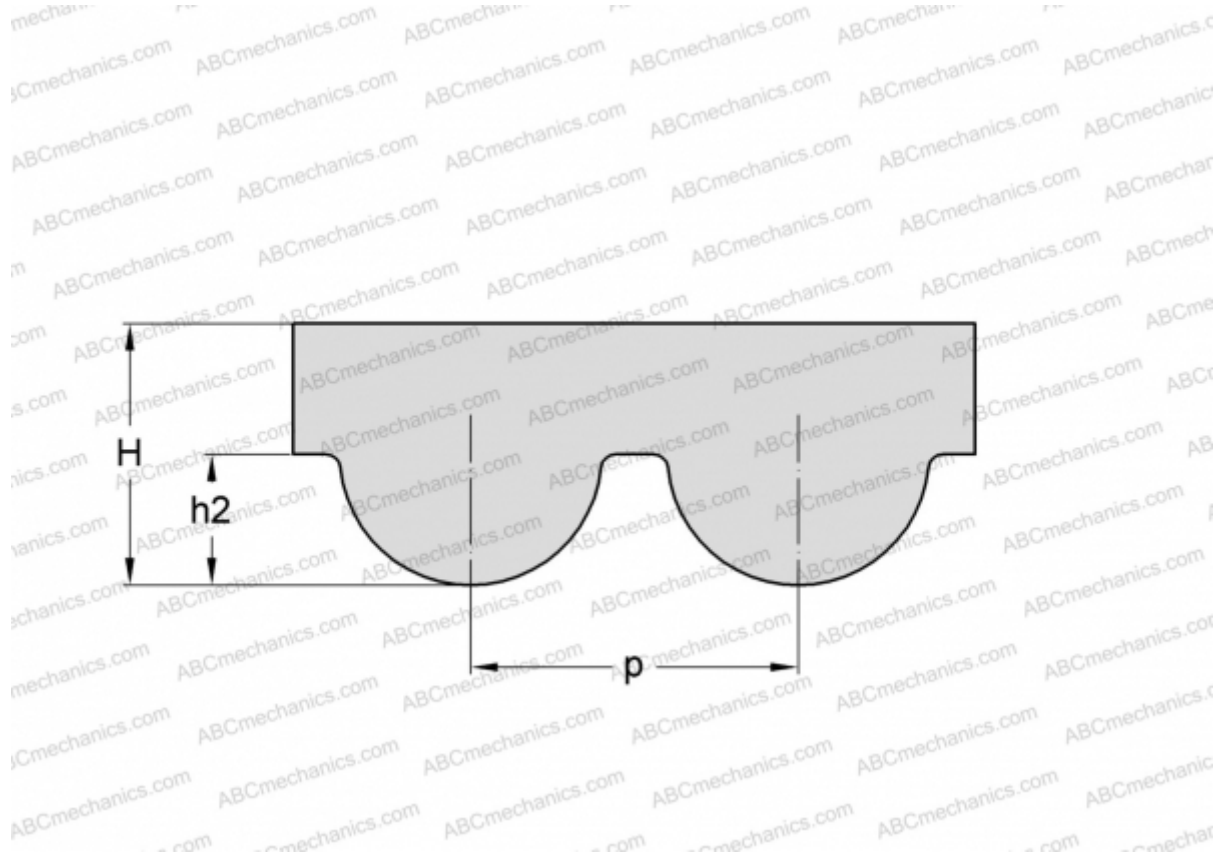

### Technical specification

#### DIMENSIONS, MM

Pitch teeth, $p$	8,000
Estimated length	1016,000
Width, $W$	50,000
Height, $H$	5,600
$h_2$	3,880
Number of teeth	127

#### MANUFACTURER

[SKF](#)