

PHG 1064-8M-50 SKF

HiTD belt

TYPE: Classical timing belts, Oneway, HiTD, Section 8M (SKF)

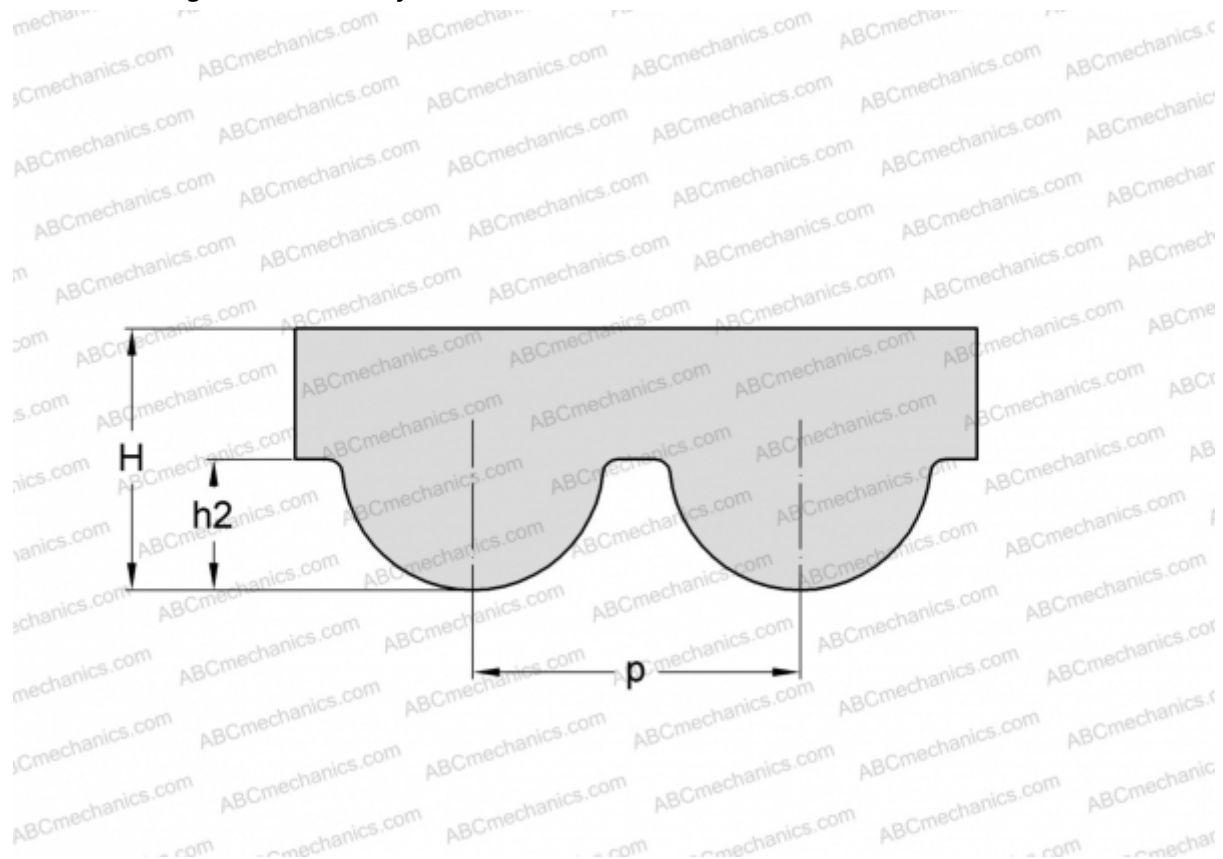

Technical specification

DIMENSIONS, MM

Pitch teeth, p	8,000
Estimated length	1064,000
Width, W	50,000
Height, H	5,600
h_2	3,880
Number of teeth	133

MANUFACTURER

[SKF](#)